

# Rinnai

## Installation and User Manual

REU-KM3237FFUD-E  
Infinity K32i

REU-KM3237WD-E  
Infinity K32e

REU-KM3237FFUDHD-E  
Infinity HDC 1500i

REU-KM3237WDHD-E  
Infinity HDC 1500e

REU-KM2635FFUD-E  
Infinity K26i

REU-KM2635WD-E  
Infinity K26e

REU-KM2635FFUDHD-E  
Infinity HDC 1200i

REU-KM2635WDHD-E  
Infinity HDC 1200e

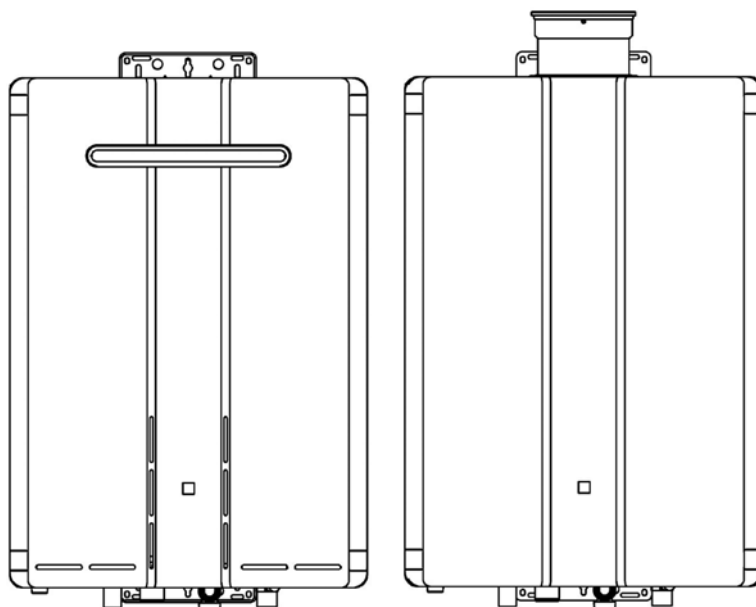

### Continuous Flow Water Heater Important.

Read these instructions carefully before attempting installation or use of this appliance. All work must be carried out by competent persons.

The Rinnai Infinity range of water heaters, when correctly installed, comply with the requirements of the United Kingdom Water Regulations / Byelaws (Scotland). These Products can be found listed in the Water Fittings and Materials Directory.



The Rinnai Infinity condensing water heaters are CE Marked as allowed by Technigas.

*Infinity K32 & HDC1500*

*Infinity K26 & HDC1200*

Certificate numbers: *E1188/5560 - E1189/5560*

ID number: *0461BU0950*

Date of Issue: *01/09/2009*

Last revision: *02/02/2010*

### **Quality System Standard**

ISO 9001 - 2000

The Design, Development, and Manufacture of Gas Water Heating Appliances done under Rinnai's Quality Management System is certified under the Quality Management System Standard ISO 9001.

Registration Number JQ0003D  
Registered since: February 1994  
Certified by JIA—QA Centre.

# CONTENTS

CONTENTS.....	3
USER INSTRUCTIONS.....	4
FEATURES AND BENEFITS.....	5
IMPORTANT INFORMATION.....	6
OPERATION WITHOUT REMOTES.....	8
STATUS MONITOR.....	8
TEMPERATURE CONTROLS.....	9
ERROR MESSAGES.....	14
RESTARTING THE RINNAI WATER HEATER.....	16
CARING FOR THE INFINITY.....	16
INSTALLATION INSTRUCTIONS.....	17
UK INSTALLATION INSTRUCTIONS.....	18
UNPACKING RINNAI WATER HEATER.....	19
OPERATION .....	20
MAIN COMPONENTS.....	23
INSTALLATION INSTRUCTIONS.....	24
FLUE REQUIREMENTS.....	29
CONDENSATE DISPOSAL.....	32
TEMPERATURE CONTROLS.....	34
EZ CONNECT.....	36
TESTING.....	37
GAS PRESSURE SETTING.....	38
DIP SWITCH SETTING.....	40
DIMENSIONS.....	42
TECHNICAL DETAILS.....	44
FLOW CHART.....	46
WIRING DIAGRAM.....	47
DIAGNOSTIC POINTS.....	49
WATER FLOW CHARACTERISTICS.....	50
LETTER OF COMPLIANCE.....	51
CE CERTIFICATE.....	52
COMMISSIONING CHECKLIST.....	54
MAINTENANCE.....	55
UK WARRANTY.....	56
SPECIFICATION.....	58
CONTACT.....	59
HEATER DETAILS.....	59

# USERS INSTRUCTIONS

The following instructions are designed for the user of the water heater. The user may not install or adjust the appliance in any way that requires the removal of the front cover of the unit. To remove the front cover of the unit you must be certified competent to do so. Information for the Installer is given on page 17.

**All work done on this appliance must be done by a qualified gas engineer. A qualified gas engineer must carry an up to date CORGI Registered Gas Installer photo identification card while working on gas appliances. If you are unsure do not be afraid to ask the engineer to show you the card. If you are still not satisfied call CORGI on 0870 401 2300 and verify the engineer's name with their database. This is for your own safety.**

## **Responsibilities of the USER**

The user must abide by all warnings given in this book. The user must only reference the user section of the book, and may not carry out any procedure listed in the installer section. This installation manual should be kept with the appliance for maintenance and user information.

The user must have the unit checked and maintained annually by a gas engineer.

The user must periodically check the water filter on the inlet to the appliance.

The user must not use the appliance in any way that it was not meant to be used. The user may only use the heater as detailed in the User portion of this manual.

Interference with a sealed component is not permitted. In case of defect parts only use genuine Rinnai components for replacement.

Conversion to other gas types should only be carried out by a qualified installer or a gas distributor according to the practice in the country where the unit is installed.

The user must not store or use any flammable vapours or liquids in the vicinity of this or any other appliance.

The user should familiarise themselves with the water heaters gas service valve and the main gas valve to the premises.

## **IF YOU SMELL GAS**

**Isolate the gas supply and get out of the building.**

**Do not try to light any appliance.**

**Do not turn any light or other electrical switch on or off.**

**Do not use any telephone in the building.**

**Call your gas engineer from a safe location and follow their instructions.**

**If you cannot reach your gas engineer ring the following:**

**National Grid 0800 111 999**

## FEATURES AND BENEFITS

Congratulations on purchasing the Technologically Advanced, Temperature Controlled, Rinnai Hot Water System.

- **Rinnai water heaters will NEVER RUN OUT** of hot water. As long as electricity, water, and gas supplies are connected, hot water is available when hot water taps are open.
- Built into the main micro-processor is the facility to **LIMIT THE MAXIMUM TEMPERATURE** of the hot water supplied. The water temperature may be set to various temperatures. This is particularly useful when the hot water unit is installed where young children or the infirm may be using the hot water. If required, the temperature can be changed via the dip switches on the PCB or with a localised controller. For further information, please contact Rinnai.
- Rinnai Infinity water heaters are powered flue appliances. This makes them **COMPACT**, saving both floor and wall space.
- The temperature of outgoing hot water is **CONSTANTLY MONITORED** by a **BUILT-IN SENSOR**. If the temperature of the outgoing hot water rises to more than 3°C above the selected temperature the burner is shut OFF and only turned ON again when the temperature falls to below the selected temperature.
- The burner lights automatically when the hot water tap is opened, and extinguishes when the tap is closed. **IGNITION IS ELECTRONIC**, so there is no pilot light. When the hot water tap is off, no gas is used.
- The Rinnai Infinity Condensing water heaters have a built in **Status Monitor** on the front of the unit to display error codes and run condition. Up to four external temperature controllers can be mounted remotely from the heater. This offers the following additional features:
  - Localised temperature setting
  - Diagnostic information
  - Error Codes
  - Clock
  - Bath fill
- 'Deluxe' Temperature Controllers are an optional extra. These provide functions including Bath Fill, Voice Prompt, and Clock Setting.
- Temperatures selected at the controllers are retained in the **SYSTEM MEMORY**.
- Operating **NOISE LEVEL IS VERY LOW**.
- **ERROR MESSAGES ARE DISPLAYED** on the Temperature Controllers, assisting with service.
- **FROST PROTECTION** device built in as standard.

# IMPORTANT INFORMATION

Excessively hot water is dangerous, especially for young children and the infirm. The water heater allows you to control the temperature of your hot water to safe levels.



Water temperature over 50°C can cause severe burns instantly or even death from scalding.

Children, disabled and the elderly are at the highest risk of being scalded by excessively hot water.

Always test the temperature of the water before bathing or showering.

Burns from hot water taps can result in very severe injuries to young children.

Hot water at 65°C can severely burn a child in less than half a second. At 50°C it takes five minutes.

Burns can occur when children are exposed directly to hot water or when they are placed into a bath which is too hot.

## DO

Do stay with children whenever they are in the bathroom.

Do take them out of the bathroom if you need to answer the phone or door.

Do test the temperature of the water with your elbow before placing your child in the bath.

Do make sure that the tap is turned off tightly.

Do consider setting your Rinnai Water Heater at a maximum temperature of 50°C.

Do install a child proof tap cover OR,

Do install a child resistant tap.

- **Consider child-resistant taps or inexpensive tap covers**, both of which prevent a child's hand from turning on the tap.
- **Consider reducing the temperature of the water supplied to the hot tap to 50°C.**

This approach can be extremely valuable because it requires a one time action for a long term reduction in risks of scalds.

This type of automatic protection is important during times when a parent or carer has been distracted.

## DO NOT

Do not leave a toddler in the care of another small child. The older child may not have safely set the temperature.

# IMPORTANT INFORMATION

Always check water temperature before use.

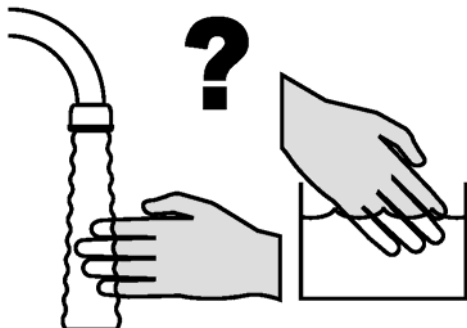

Refer to warning about hot water on page 6 for important safety information.

Hot water may go cold without warning at very low water flows (less than 3 l/min).

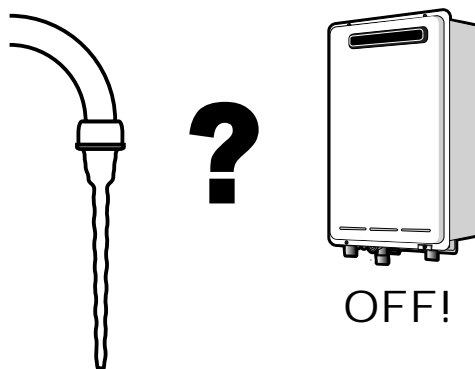

The delivered water temperature is controlled automatically. The water from the hot tap may be reduced after the temperature shown on the remote control is raised. The water flow may also vary with the temperature of the incoming water supply.

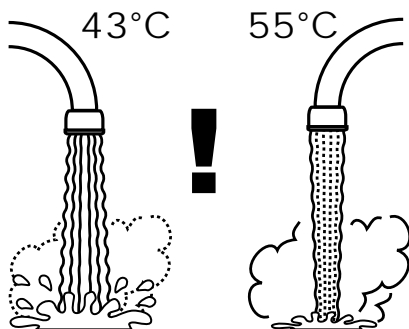

If freezing temperatures are expected, turn off the water and gas, and drain the water heater.

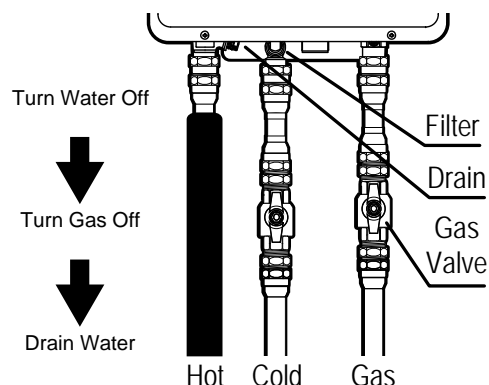

If the power is left on the Automatic Frost Protection will prevent the unit from Freezing. Frost protection is standard on all units.

Keep flammable materials, trees, shrubs, chemicals, etc. away from the flue outlet / terminal.

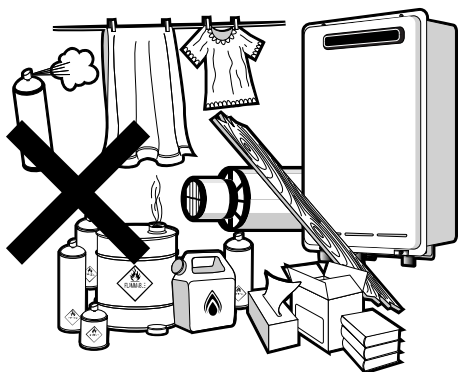

Do not spray water into flue terminal

Do not touch the flue outlet. Do not insert objects into the flue outlet / terminal.

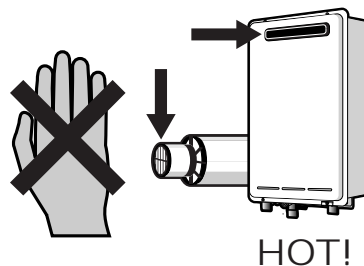

On cold days steam may be discharged from the flue outlet. This is normal, do not be alarmed. It does not indicate a fault.

## OPERATION WITHOUT REMOTES

Rinnai Infinity products have no pilot light and operate automatically as soon as water flow is sensed.

The burner ignites with electronic ignition and the flame extinguishes as soon as water flowing through the appliance stops.

### Turn On by opening the hot water tap

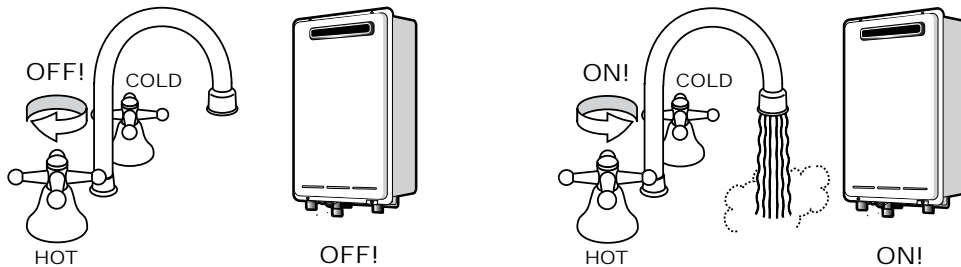

NOTE

The Rinnai Infinity range of water heaters are factory preset to a temperature of 55°C; the HD range are preset to 65°C. Other limits, lower or higher, are available on request. Temperature controllers are available to allow precise digital temperature control. Controllers can be installed at any time after installation of the hot water unit.



CAUTION

Excessively hot water is dangerous. Rinnai water heaters allow you to control the temperature of your hot water to a safe level.

Water temperatures above 50°C can cause severe burns instantly, such scalding may even result in death. Those most at risk are children, disabled, elderly and the infirm. Hot water at 65°C (a very common water temperature in the UK) can severely burn a child in less than half a second. At 50°C it takes five minutes.

Consider using Thermostatic Mixing Valves on the Hot Water Outlets.

## STATUS MONITOR

The new series of Rinnai Water Heaters have a built in status monitor on the front.

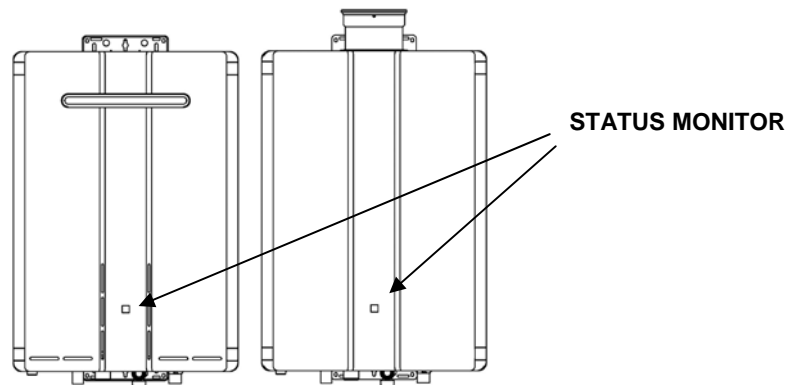

The status monitor has three conditions:

1. The water heater is off (no water flowing): the monitor is blank.
2. The water heater is on (heating water): The monitor displays the set temperature.
3. The water heater should be on, but is not (water is flowing, heater is not on): The monitor will display a flashing error code.



NEW FEATURE



# TEMPERATURE CONTROLS

The purpose of a Temperature Controller is to enable the user to have localised control over the hot water supply. Used correctly, the hot water unit will supply hot water at the temperature selected, even when the water flow is varied, or when more than one tap is used. Adjustments to the operation of your hot water unit can be made with any of the Temperature Controllers. Each Temperature Controller can be individually programmed.

Up to four Universal and/or Deluxe Temperature Controllers can be fitted with Rinnai water heaters. Universal Controllers allow temperature selection only and one comes as standard with the water heaters. Deluxe Temperature Controllers are an optional extra. These controllers have temperature selection, bath fill, voice prompt, and time clock functions. When more than one Universal Controller is used one may be set as the Master Controller to allow temperatures above 50°C.

Various water temperatures (°C) can be selected as follows:

## **Universal Controller:**

37, 38, 39, 40, 41, 42, 43, 44, 45, 46, 48, 50°C

## **Master Universal Controller:**

37, 38, 39, 40, 41, 42, 43, 44, 45, 46, 48, 50, 55°C ( 60, 65°C HD )

## **Deluxe Bathroom Controller:**

Hot Water Delivery: 37, 38, 39, 40, 41, 42, 43, 44, 45, 46, 48, 50°C

Bath fill Delivery: 37, 38, 39, 40, 41, 42, 43, 44, 45, 46, 47, 48°C

## **Deluxe Kitchen Controller:**

37, 38, 39, 40, 41, 42, 43, 44, 45, 46, 48, 50, 55°C ( 60, 65°C HD )

If a temperature of 43°C or higher is selected on any controller and this temperature is then decreased to below 43°C and increased again whilst the water is running, the maximum selectable temperature will be 43°C. This provides additional safety for the user.

## **Suggested temperatures are:**

Kitchen 50°C - 65°C\*; Shower 39°C - 43°C; Bath fill 39°C - 45°C

*\* This temperature may not be available on all installations.*

These temperatures are suggested starting points for selection. You may find higher or lower temperatures are more comfortable. Maintaining lower temperatures helps to save energy. To obtain water temperatures lower than 37°C simply add cold water.

When multiple temperature controllers are used they allow the temperature to be set from various locations by pushing the transfer button which gives that controller priority over the system. The temperature selected by the controller with priority will be available to all outlets.

# TEMPERATURE CONTROLS

Remote temperature controllers provide control over the water temperature. Rinnai water heaters can be operated with 1, 2, 3, 4 or no temperature controllers.

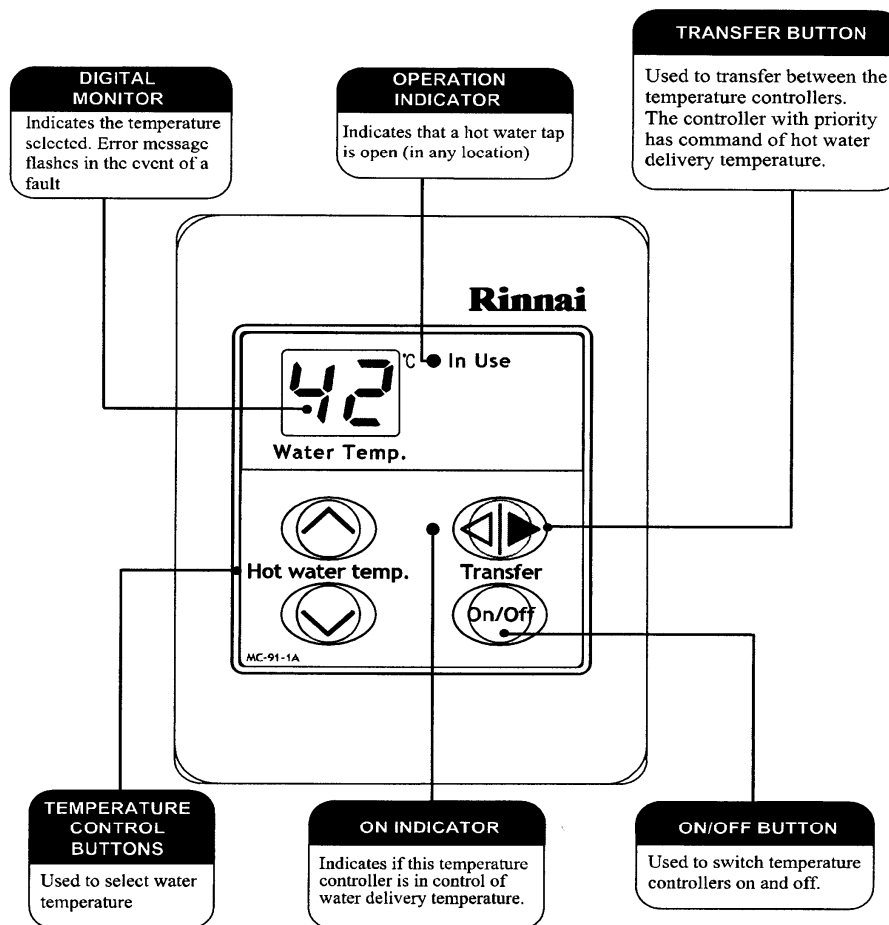

NOTE

Each time a button is pressed, a BEEP will sound. The BEEP sound can be muted by depressing the Temperature Controller Up and Down buttons simultaneously for more than 3 seconds. This can be done for each Temperature Controller. To return to original settings, repeat this step.

## Safety features

Whilst the hot water tap is open, the following safety features apply:

- Temperature selection cannot be transferred.
- The temperature setpoint on the controller with priority can always be lowered, but the setpoint can only be raised to 43°C.
- Other controllers are unable to take priority or change the delivery temperature of the water.
- If off, the controller cannot be turned on.



NOTE

The temperature of the outgoing water is constantly monitored by a built in sensor.

If the temperature of the outgoing hot water rises to more than 3°C above the selected temperature shown on the digital display, or the preset limit if controllers are not fitted, the burner will automatically go out.

The red operation indicator will also go out.

The burner will ignite again once the outgoing hot water temperature falls to that shown on the digital display (or the pre-set limit of the Rinnai Infinity heater).

# TEMPERATURE CONTROLS

## Using the Temperature Controllers

Press the **ON/OFF** button on a temperature controller after making sure that water is not flowing.

The system will become active, the temperature will default to 40°C and the controller that turned the system on will have priority.

The temperature setting on the controller will light up.

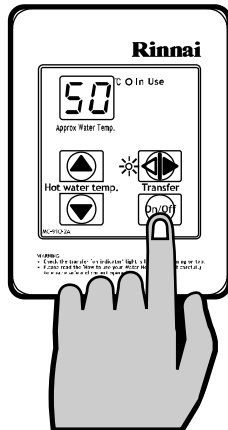

## Adjusting Temperature

Simply press the Hot Water Temperature Up or Down arrow button until the desired temperature is displayed on the digital display.

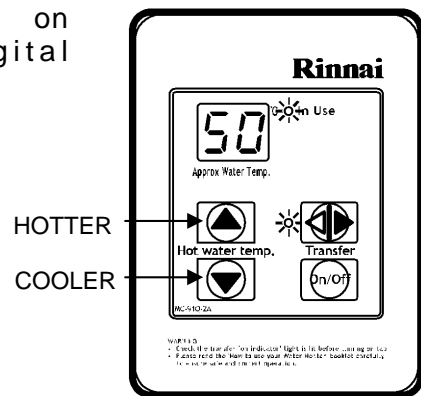

## Using Hot Water

To operate the heater, simply turn any hot water tap on. This will automatically light the burner providing hot water. The red **IN USE** indicator will glow on the temperature controller.

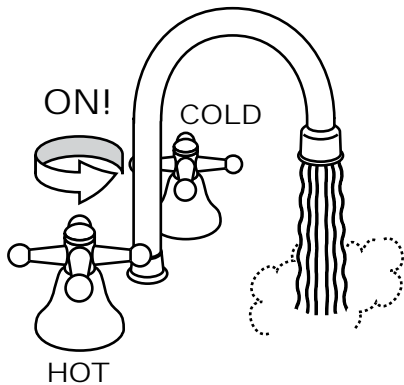

## To turn off your hot water system

During normal operation the system is left on.

To turn the system off simply press the **ON/OFF** button on any temperature controller (where fitted). This will shut the water heater down completely including the temperature controller digital display.

The Digital Monitor will go out.

If hot water taps are opened when the Rinnai Infinity is off, cold water will flow from the taps.

If the system is to be left off over the winter be sure to drain it down if there is a possibility of freezing temperatures.

## Using High Temperature Display Controllers

You will need to program the Master controller if you want to display and use temperatures over 50°C. Programming only needs to be done on Master universal controller; other universal controllers will not allow this.

Deluxe Kitchen controllers are supplied already programmed to allow high temperatures.

**STEP 1:** On the Master controller only press and hold the **Transfer** and **ON/OFF** buttons simultaneously (see Fig. 1) until a “beep” is heard (approx. 5 seconds).

**STEP 2:** When the Primary controller is switched on it should be possible to select temperatures higher than 50°C. If not repeat STEP 1.

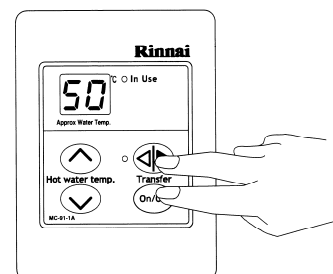

Fig. 1



NOTE

**If the master controller is replaced, repeat STEP 1 above for the new controller.**

# TEMPERATURE CONTROLS

## Using 2 or more Universal Temperature Controllers.

### Switching the system ON.

The hot water system and all controllers can be switched ON and OFF from any controller by pressing the **ON/OFF** button as shown. When the system is turned ON the water temperature display will be lit.

During normal operation the system is left ON. Do not push the **ON/OFF** button when water is running.

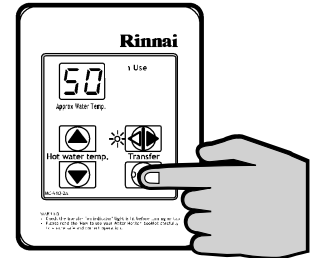

### Using hot water.

Ensure the system is switched **On** by verifying the temperature display is lit. Ensure the local controller has priority by verifying the **Transfer** LED indicator is lit. If it is not then press the **Transfer** button once. This gives the local controller priority of temperature over the system.

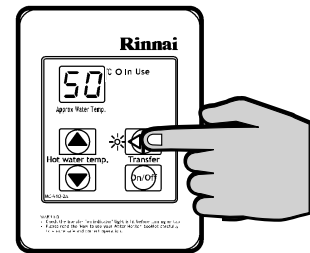

Select the desired temperature using the **Hot water temp.** buttons. The selected temperature will be displayed on all controller displays. This is the water temperature which will be supplied from the heater.

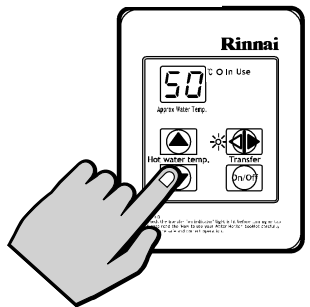

### Bathroom temperatures should be no more than 50°C.

Open the hot water tap. The appliance will be activated and the **In Use** indicator will be lit.

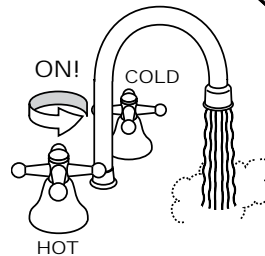
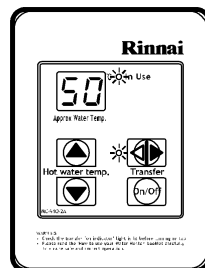

## Using 4 Universal Temperature Controllers.

You will need to activate the fourth controller.

**STEP 1:** On the Master controller press and hold the **Transfer** and **ON/OFF** buttons simultaneously (see Fig. 2) until a “beep” is heard (approx. 5 seconds).

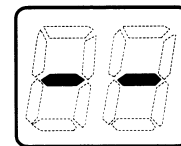

Fig. 1

**STEP 2:** Check that the display on all Four controllers is lit and displaying a temperature when switched on. If any ONE of the controllers displays two dashes (see Fig. 1) in the display repeat STEP 1.

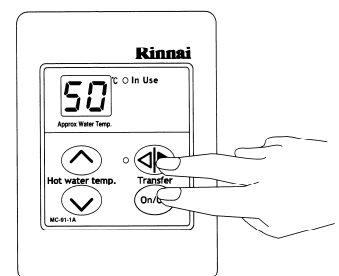

Fig. 2



NOTE

*If the master controller is replaced, repeat STEP 1 above for the new controller.*

# TEMPERATURE CONTROLS

Do not push the ON/OFF button on the Master controller after transferring priority of temperature selection to a Secondary controller as the system will shut down.

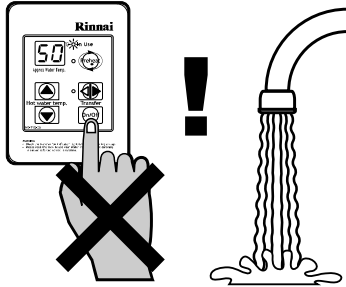

**Do Not Turn OFF** the Master Controller

Temperature priority cannot be switched to another controller when the water is flowing through the water heater.

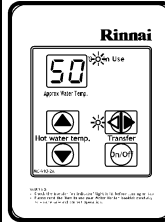

Controller 1  
in use

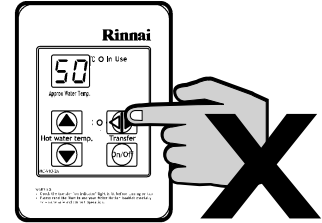

Controller 2  
cannot take  
priority

If a temperature over 50°C has been selected on a controller and priority of temperature selection is transferred to another controller, then back again, the temperature on the controller will automatically drop to 50°C. If the set point is 50°C or less it will not alter. This is a safety feature.

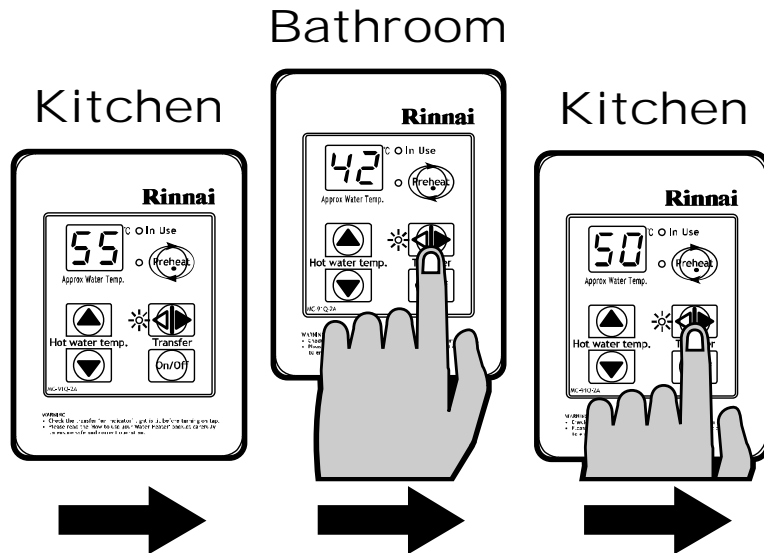

Depending on the weather conditions and the length of the pipe between the heater and the tap in use, there may be a variation between the temperature displayed at the controller and the temperature at the tap.

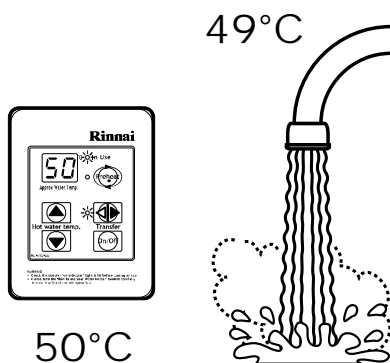

Do not clean the control with solvents or detergents. Use only a soft damp cloth.

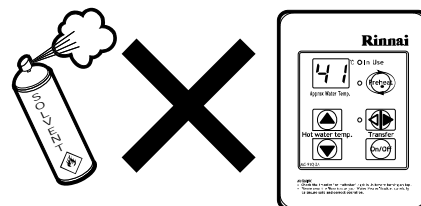

# ERROR MESSAGES

Rinnai water heaters have the ability to check their own operation continuously. If a fault occurs, an error code will flash on the Digital Display (and on the Status Monitor) if you have temperature controllers installed. This assists with diagnosing the fault, and may enable you to overcome a problem without a service call. Please quote the code displayed when enquiring about service.

Code Displayed	Fault	Remedy
-	Noticeable reduction in water flow	Inlet water filter needs to be cleaned.
03	Power interruption during operation (water will not flow when power returned)	Turn off all hot water taps and circulating pumps. Press 'On/Off' twice
10	Not enough combustion air	Check for physical blockages around air intake or exhaust. Check combustion fan.
11	No Ignition / Gas supply	Check gas valves, gas supply and sparker unit.
12	Flame failure / Earth Leakage	Check gas valves and gas supply. Check flame rod. Check earth wire lead. Check remote control.
14	High flame safety device	Service Call
16	Over temperature warning	Service Call
25	Condensate pipe blockage	Check for blockage on condensate drain path.
32	Outgoing water temperature sensor faulty	Service Call
33	Heat exchanger outlet sensor faulty	Service Call
52	Gas modulating valve faulty	Service Call
61	Combustion fan failure	Service Call
65	Water flow control faulty (does not stop flow properly)	Service Call
71	Micro-processor failure	Service Call
72	Flame rod circuit error	Service Call
LC (00)***	Scale build-up in heat exchanger	Service Call

\* In all cases, you may be able to clear the Error code by turning the hot water tap OFF, then ON again. If this does not clear the error, try pushing the On/Off button OFF then ON again. If the Error Code still remains contact Rinnai or your nearest service agent for advice.

\*\* Faults caused by insufficient gas/water supply or gas/water quality and installation errors are not covered by the manufacturer's warranty.

\*\*\* The display will alternate between temperature setting and LC code. The controller will continue to beep. The LC code will reset if power is turned Off and then On.

# ERROR MESSAGES

## Troubleshooting without controllers

If you have not installed temperature controllers and experience the following symptoms, please carry out the suggestions below. If symptoms continue, please contact Rinnai for advice.

Fault	Remedy
Heater does not attempt to start at all.	Check the power is on at the heater. Check the cold water valve supplying the heater is open.
Heater starts then shuts down immediately.	Check the power is on. Check the gas valve at the heater and at the gas meter is fully open. Open the hot water tap fully.
Heater starts then the water goes cold.	Check the power is on. Open your hot water tap further or try another hot outlet.

NOTE: Faults caused by insufficient gas/water supply or gas/water quality and installation errors are not covered by the manufacturer's warranty.

## Installations with circulation pumps

### With temperature controller fitted.

If you have an installation using a secondary circulation pump this must be switched off so that there is no flow through the heater when starting or after a power failure. If the pump is running the unit will not operate (no display on the controller). Isolate pump then start heater before restarting pump. This is a safety feature.

The pump should also be fitted with a timer to prevent the consumption of energy while the building is not used. The timer should bring the system back on at least one hour before it is to be used.

### Without temperature controller fitted.

The heater should automatically reset and provide water at the temperature set by the internal limit switches.

# RESTARTING THE RINNAI WATER HEATER

The heaters should be restarted in this manner.

## Standard system.

### Single or multiple water heaters without remote controllers.

The heaters will automatically reset without any user involvement.

### Single or multiple water heaters with remote controllers.

The heaters will be required to be switched on using the ON/OFF button on a remote controller. Ensure that all taps/water outlets are closed and no water is flowing through heaters.

## Hot water system incorporating secondary recirculation pump.

### Single or multiple water heaters without remote controllers.

The heater(s) will automatically reset without any user involvement.

### Single or multiple water heater(s) with remote controller(s).

To reset the heaters follow the steps.

1. Turn off all hot water taps.
2. Turn off supply to secondary circulating pump or alternatively, isolate pump flow.
3. Turn on heater at remote control.
4. Select required temperature.
5. Switch on supply to secondary circulating pump or open valve on pump flow.

The heater will now be ready to supply water at the set temperature.

If following the above procedure does not reset the heater switch it on and off at its main supply, and then go through these steps again. If heater is still not working call your local service agent or Rinnai for assistance.

# CARING FOR THE INFINITY

## Maintenance

Even if there does not seem to be a problem with the water heater it is required in the UK that all gas appliances are serviced every year by a certified gas engineer. This is to ensure continued safety of the gas appliance. If you need a recommended service engineer contact Rinnai or your supplier. The installer can refer to page 55 for main maintenance of appliance. For more detailed instructions on maintenance contact Rinnai or your supplier.

## Care

When the appliance casing, operation panel, and remote controls surfaces become dirty gently wipe them clean with a soft, damp cloth. Do not use detergents on these parts.

## Filter

The water heater has a filter on the cold water inlet connection. This filter will need to be cleaned occasionally. How often will be determined by the local water conditions. The water filter can be located on the diagram on page 20-21. Isolate the cold water inlet and hot water outlet with the valves near the heater. Release the pressure in the heater by unscrewing the drain valve (shown on page 20-21.) Then remove the filter, clean it and replace it.



## INSTALLATION INSTRUCTIONS

### **STOP**

To go beyond this point in the manual you must be a registered gas engineer.

Do not attempt to install this appliance if you are not qualified. This can void the warranty.

If the information in this manual is not followed exactly a fire or explosion could result.

This manual must be read in its entirety before installing the appliance.

If you are unsure of any point contact Rinnai or your supplier.

# UK INSTALLATION INSTRUCTIONS

## IMPORTANT INFORMATION

**This appliance may only be installed by someone certified competent to do so. At the time of printing the only people deemed competent to install this appliance are those that are CORGI registered for this type of appliance in this type of location who have a current ACS certificate.**

1. **Gas safety (Installation & Use) regulations 1998** are the 'Rules in force'. In your own interest and that of safety, it is law that all gas appliances are installed by competent persons in accordance with the above regulations. Failure to install appliances correctly could lead to prosecution. Other persons should NOT attempt to install this equipment.
2. **Building Regulations G3** require installers of unvented systems to be competent to do so. Competence can be shown by holding a current certificate in Unvented Domestic Hot Water Systems. If the Infinity is installed in a flow and return, or tank system, or any other closed system then the system is unvented.
3. Installation must be carried out in accordance with the current issue of the following:

Building Regulations issued by the Department of the Environment

Building Standards (Scotland) Regulations.

I.E.E. Wiring regulations for electrical installations.

Gas safety (Installation and Use) Regulations current issue.

BS 5546

BS 5440

BS 6891

BS 5482

BS 6700

BS 6644

Institute of Gas Engineers Publications

Local byelaws

Water regulations

Health and safety at work etc. Act 1974

IGE/UP/10 Part1 Edition 2.

Building Regulation J and G

Such other specifications and regulations that may supersede or complement the above documents.

It is the installer's responsibility to ensure that the unit has been installed to all current requirements.







**Please be sure that you are fully aware of your obligations and responsibilities under these regulations.**

**In case of defect parts only use genuine Rinnai components for replacement.**

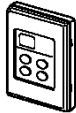

# UNPACKING RINNAI WATER HEATER

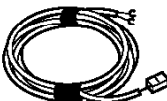
- After unpacking the appliance check for damage, if the heater is damaged contact your supplier immediately. Do not install a damaged appliance before checking with your supplier.
- A heater accessories pack is inside the carton. One remote control is supplied with the Infinity range of water heaters. Remote controllers are not supplied with the Rinnai HD range of heaters because they are commercial units. If you require controllers in commercial situations they are compatible with the HD range and available from Rinnai UK or your supplier.
- Check that the appliance supplied is the correct gas type and pressure for the installation. Refer to the data plate located on the left-hand side of the appliance.
- Remove the heater and the accessories from the carton, and check that all the parts are included. The remote control cable is provided with spade connectors.

## Remote Control Parts

Quantity	Diagram	Description
1		Temperature controller MC-91-1A
1		Cable Clamp (to fix one Control Cable)
1		Cable Clamp (to fix two Control Cables)
5		Spade Connectors
1		Control Cable 20 metres
1		Clamp Screw

## Unit Mounting Fasteners

Quantity	Diagram	Description
5		Screw
5		Wall Plug

# OPERATION

## Infinity K32i and HDC1500i

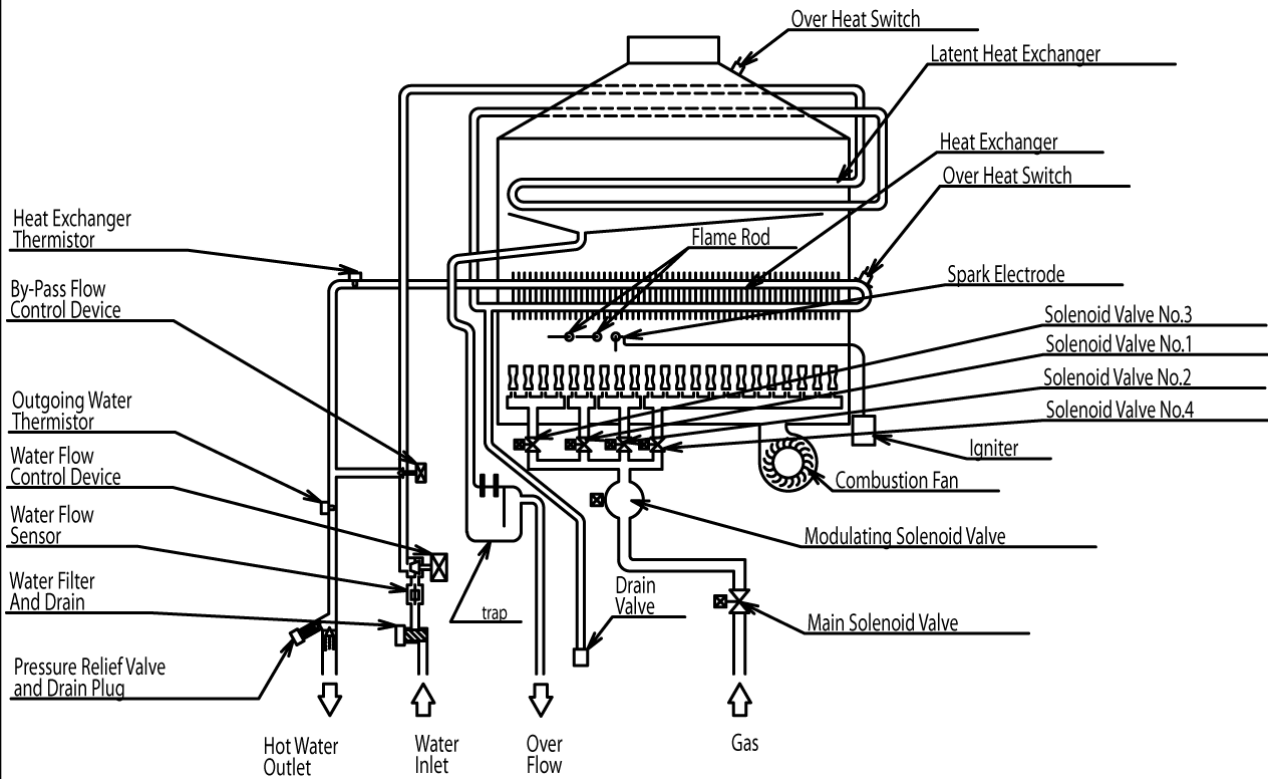

## Infinity K32e and HDC1500e

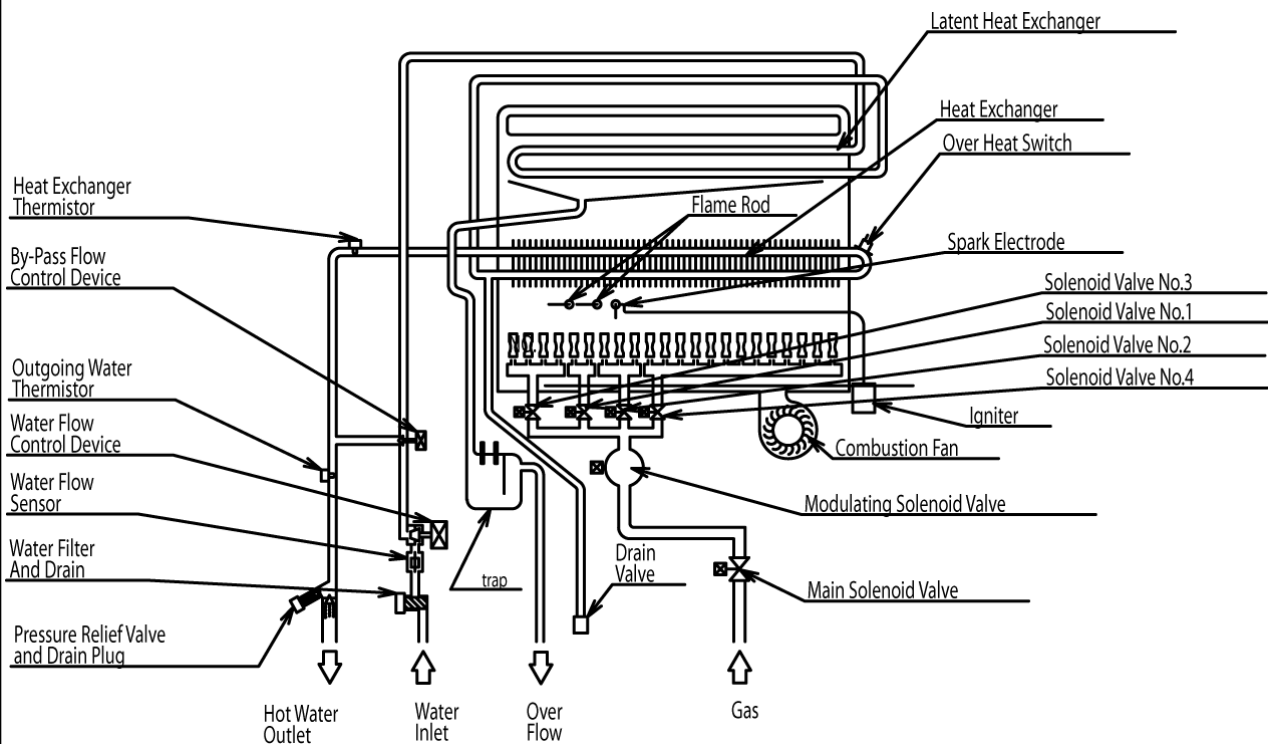

# OPERATION

## Infinity K26i and HDC1200i

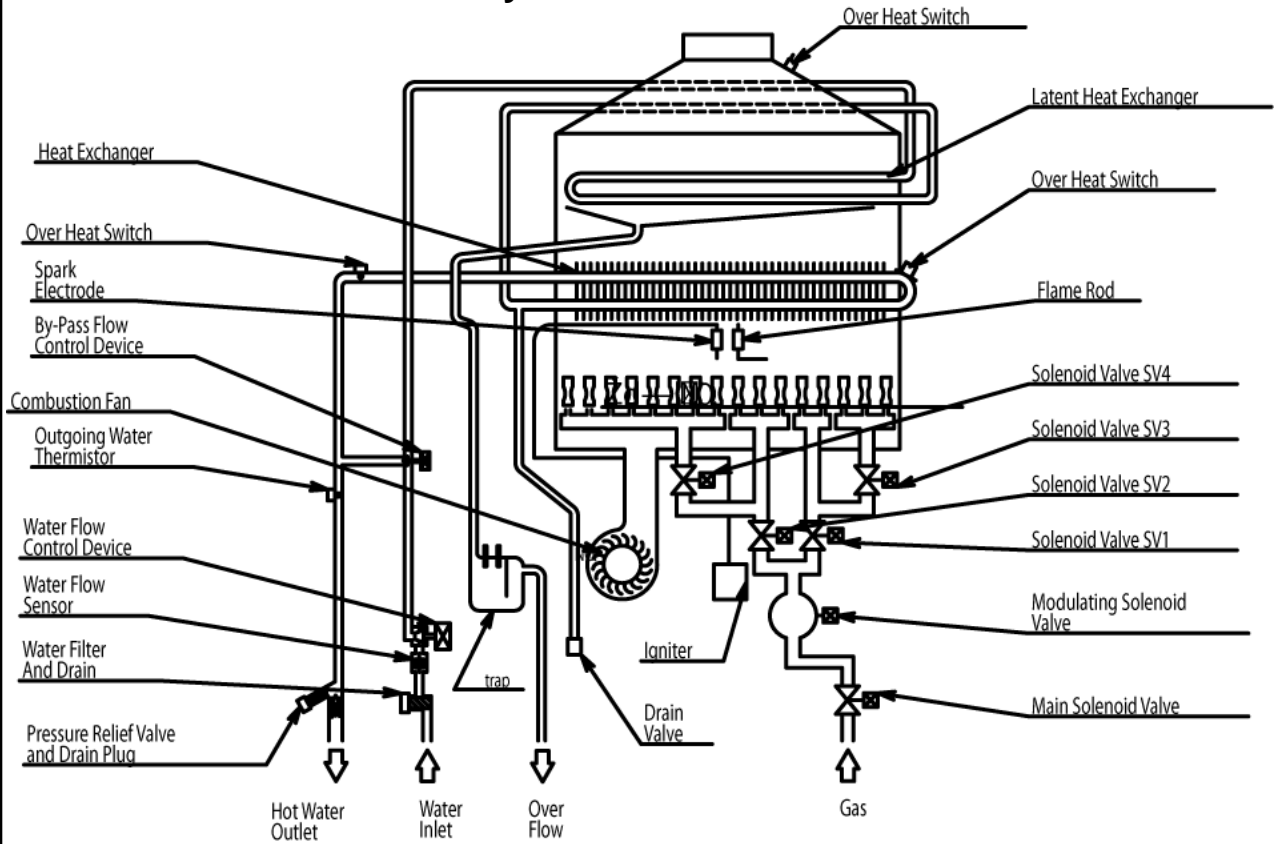

## Infinity K26e and HDC1200e

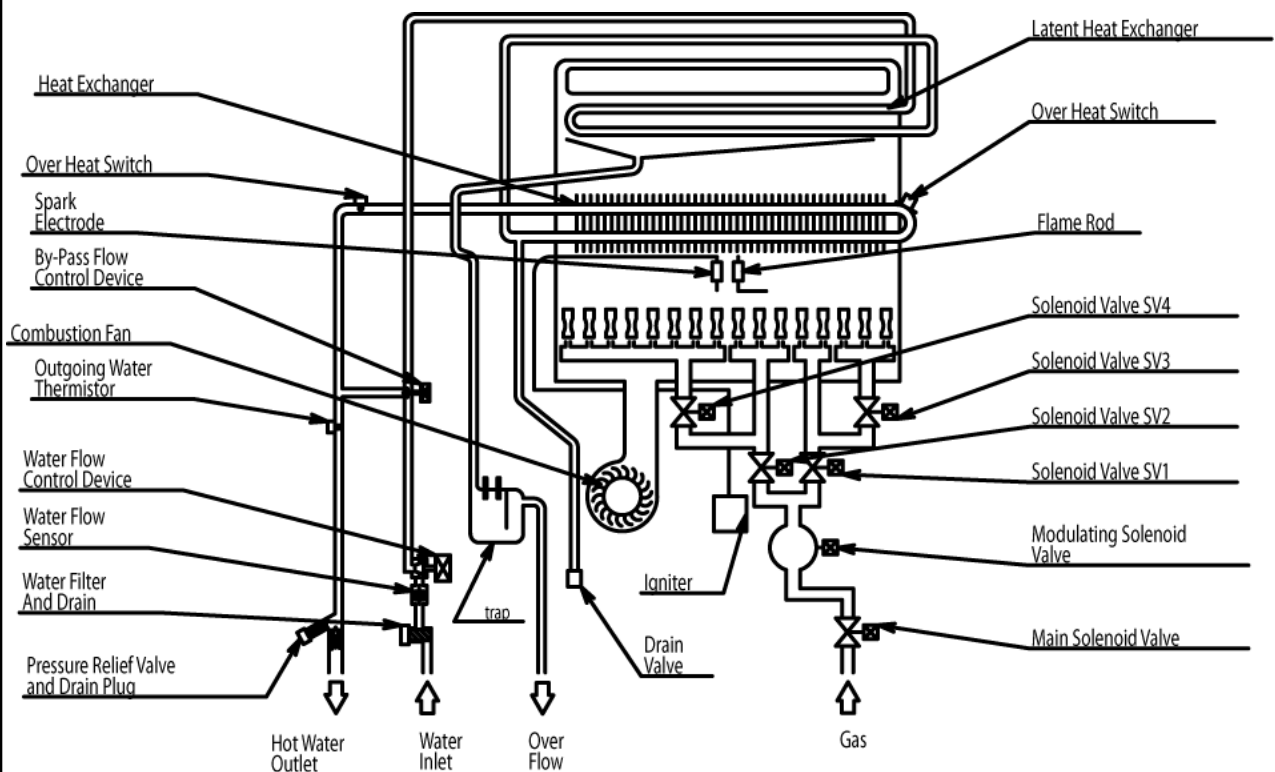

# OPERATION

## Ignition

Press ON/OFF Button of **Remote Controller** to turn on unit and the remote controller display and priority LED will light up.

When a hot water tap is opened the **Water Flow Sensor** revolves and sends a pulse signal to the **Printed Circuit Board (PCB)**. When the PCB detects water flow it compares the measured temperature to the temperature setpoint. If required it begins the ignition process with the **Combustion Fan Motor** starting first.

Once the air proving is made the **Main Solenoid Valve** and **Change-over Solenoid Valves** are opened and the **Burner** is lit by the sparking **Igniter**.

## Temperature Control

Once the **Flame Rod** proves ignition the Infinity modulates by controlling the gas rate, combustion air, and water flow to precisely heat the water. This control is done by measuring the outgoing water temperature with a **Thermistor**.

## Standby

When the hot water tap is closed the PCB no longer receives a pulse signal from the Water Flow Sensor. The PCB shuts the Main Solenoid Valve and Change-over Solenoid Valves and the Burner extinguishes.

# MAIN COMPONENTS

## 1. Gas Control Unit

### 1.1 Modulating Valve

This device is used by the PCB to adjust the volume of gas to the burner in proportion to the volumetric flow rate of water in order to maintain a supply of constant temperature hot water amid changes in water flow rates and incoming temperatures.

### 1.2 Change-over Solenoid Valves

Additional solenoid valves are included to section the burner and stage the control in 6 steps. This gives the Burner more steady combustion at the required capacity and allows the water heater to operate at very low flow rates and temperature rises.

## 2. Flame Rod

Monitors combustion characteristics inside the combustion chamber. If the flame fails, gas supply is stopped. Works through rectification of the combustion flame. An AC voltage is supplied to the flame rod. Electrons can only pass from the rod to the earthed burner through the flame, and never from the burner to the rod, so the resultant DC current is used to prove combustion. When the DC current is present the burner has normal combustion, if the DC current is not present (or an AC current is present) the unit shuts the solenoid valve.

## 3. Thermal Fuse

The thermal fuse is an electric link which must be intact for the unit to operate. If the thermal fuse reaches a set temperature it will melt and the unit will shut down. The thermal fuse must be replaced if it melts. It is to protect against overheating and heat exchanger splits where water may leak out and be superheated into steam.

## 4. Overheat Safety (Bi-metal Switch)

This Bi-metal Switch is fixed at the inlet bend of the Heat Exchangers final pass. If the temperature outlet from the heat exchanger reaches 97°C the bi-metal switch will open and the solenoid valve circuit is broken. This will cease combustion in case of overheat.

## 5. Combustion Fan

The combustion fan supplies primary air into the burner wings and secondary air up through the Bunsen style burners. The fan is DC low voltage and the speed is controlled by the PCB depending on the hot water supply and temperature. The fan speed is compared to the current required to attain that speed for air proving. If the fan current is over or under the parameters for the given speed the unit will shut down on air proving.

## 6. Water Flow and Bypass Servos with Water Flow Sensor

### 6.1 Water Flow Sensor

Water flow sensing is done with a small turbine that spins when water travels through it in the correct direction. Each of the four fins on the turbine has a small magnet on it. Outside of the valve there is a magnetic sensor that detects the speed that the turbine is revolving. The revolution speed is input to the PCB which relates this speed to the water flow volume and determines whether it is sufficient for ignition.

### 6.2 Water Volume Flow and Bypass Servo

Water flow control is achieved through the use of servo driven water flow and bypass valves. Both servo motors are controlled by the PCB. The 'Water Flow Valve' restricts the flow of water into the heat exchanger assembly if the programmed temperature cannot be achieved. This will limit the maximum water flow, and will limit the hot water flow further when the burner is at high fire to ensure the temperature setpoint is met.

During normal operation at low (less than 60°C) setpoint, cold water from the inlet valve is mixed with hot water from the heat exchanger outlet. The 'Bypass Valve' mixes the correct proportion of cold and hot water to ensure accurate hot water delivery temperature over the available range of flow rates. For temperature setpoint over 60°C the bypass servo will be shut. The water flow and bypass valves are a combined assembly on the cold water inlet of the appliance.

# INSTALLATION INSTRUCTIONS

## External Models

The new external Rinnai Infinity Condensing water heaters are designed for '**Outdoor**' Installation only. As such, it must be located in an above ground, open air situation with natural ventilation, without stagnant areas, where products of combustion are rapidly dispersed by wind and natural convection.

The exhaust slot on the front should follow the same location guidelines as a balanced flue terminal. Ensure that the flue terminal and hot water outlet connection cannot be touched by children. The exhaust slot must be clear of obstructions and shrubbery.

## Internal Models

The new internal Rinnai Infinity Condensing water heaters are designed for '**Indoor**' installation only. It may be installed 'Outdoors' in an enclosure if the requirements are satisfied. An enclosure is defined as a compartment, enclosed area or partitioned off space primarily used for the installing of the appliance. If installed in an enclosure, either Internally or Externally, the location should be ventilated and provision must be made for the safe disposal of any leaking water to an exposed location.

When positioning appliance the flue terminal clearances must be in accordance with local requirements. Consideration should be given to other appliances, openings, and boundaries. Multiple heater installations can be installed with the heaters manifolded together. The minimum distance required between the heaters may then be based on the necessary clearances between flue terminals. The internal units Infinity may not be installed in a humid area.

## All Models

LPG appliances may not be installed in basements or below ground level.

The wall or structure on which the heater is mounted must be capable of supporting the weight of the appliance (listed on page 58) and associated pipework. The heater must be installed in a vertical position with the gas and water connections on the underside pointing downward. Ensure that suitable screws or bolts are used to secure the water heater to the wall. Bracket and fixing hole locations are shown on the template included. The top bracket has a keyhole slot so that the appliance can be hung on one screw, and then the other fixings can be added to secure the unit.

The appliance should be placed as close as practical to the most frequently used hot water outlet point or points to minimise the delay time for hot water delivery. For installations where the distance between the unit and hot water outlet points is considerable, the appliance can also be fitted in a 'flow and return system' which minimises the waiting time for hot water delivery. Alternatively, multiple appliances can be strategically placed to service outlet points with minimal delay time. Contact Rinnai or your supplier for further information.

## **THIS APPLIANCE MUST NOT BE USED AS A DOMESTIC SPA OR SWIMMING POOL HEATER.**

Please consider the location of the appliance and what is below it. As with any water fitting there is a possibility that a connection or component could develop a leak over time; or water may spill during servicing of the appliance. Rinnai can not be held responsible for any consequential water damage so it may be necessary to fit a drain pan under the unit.



# INSTALLATION INSTRUCTIONS

## Clearance

The appliance must be in an accessible location. Sufficient clearances shall allow access to, and removal of, all serviceable components. The following clearances should be followed.

Clearances in mm	From Combustibles		From Non-Combustibles	
	Internal Units	External Units	Internal Units	External Units
Above	300	300	50	50
Behind	0	0	0	0
In Front	600	600	600	600
Sides	50	150	15	15
Below	300	300	50	50
Flue pipe	0	-	0	-

## Water Supply

Where the water supply pressure exceeds 10 bar, an approved pressure reducing device must be fit at the inlet of the appliance. To achieve the maximum rated flow a minimum water supply pressure of 2.2 bar is required at the appliance inlet. The unit will operate at lower supply pressures but the maximum flow rate will not be achieved. Most installations will use high temperature setpoints which will reduce the available flow rate and heat exchanger pressure drop, and therefore less pressure will be required at the inlet. See the pressure chart on page 50. Contact Rinnai or your supplier for 'gravity fed' or 'low pressure' hot water installations.

Water pipe sizing and layout should be designed correctly to ensure the given water flows from the appliance are available. All hot water pipework should be insulated to optimise maximum performance and energy efficiency.

## Water Connection

Connect the hot and cold water supply pipes as shown on page 27. An approved isolation valve and strainer **MUST** be installed in the cold water inlet pipe. An approved isolation valve and draining point should be installed in the hot water outlet pipe. There must be a union or release fitting on the heater side of the isolation valves. An unvented kit to local regulations must be installed in the pipework when the system is closed (i.e. has a flow and return, or tank). Positions of the cold water inlet, hot water outlet and gas connections are shown on page 42-43.

If the heater is in a hard water area a suitable water conditioning device must be installed to prevent the build up of limescale within the heat exchanger. Heat exchangers damaged by scaling are not covered by the manufacturer's warranty.

Description	pH	Total Dissolved Solids (TDS)	Total Hardness	Chlorides	Magnesium	Calcium	Sodium	Iron
Maximum Recommended Levels	6.5 - 9.0	600 mg/litre	150 mg/litre	300 mg/litre	10 mg/litre	20 mg/litre	150 mg/litre	1 mg/litre

## Gas Connection

Check pipe sizing required for the heater input. The heat input for the water heater is shown on page 44-45. The size of the gas meter (or regulator) and pipework must be sufficient for all appliances on the main. Sufficient gas must be available at the appliance if correct operation is to be expected; insufficient gas will damage the unit. An approved gas isolation valve must be fitted at the gas inlet. A union or release fitting should be installed after the isolation valve.

## Electrical Connection

The appliance must be earthed. The appliance is suitable for 230VAC – 50Hz mains only and all wiring must be carried out to local regulations.

# UK INST. INSTRUCTIONS

## Water Connection

For all closed systems (with flow and return or tank) the system must incorporate an unvented kit with the components shown below. The safety relieve valve must discharge safely into a suitable drain via a tundish.

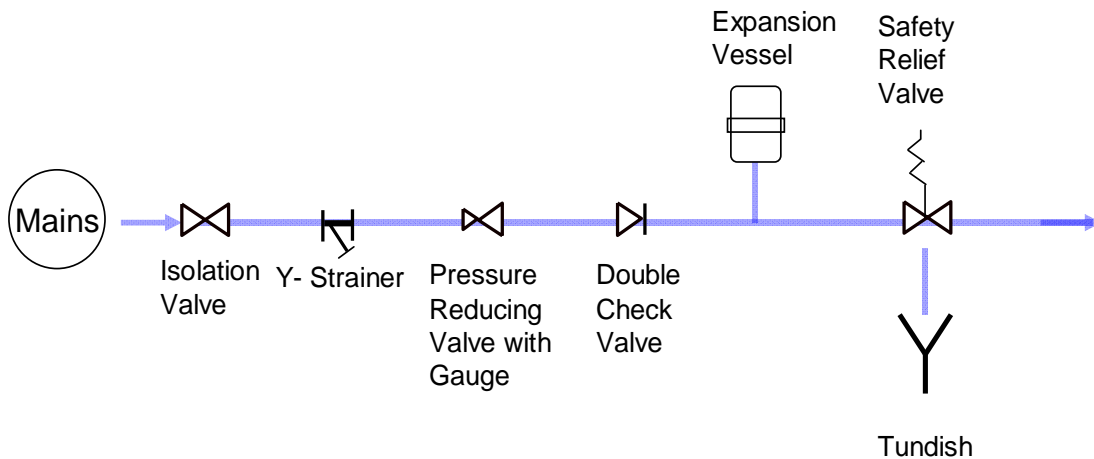

## Gas Connection

Refer to BS6891 (Natural Gas) and BS5482 (Propane) for guidance on correct pipe sizing calculation. There must be 20 mbar Natural Gas (G20) or 34.5 mbar Propane (G31) at the inlet of the appliance with all appliances at high fire.

## Electrical Connection

The heater electrical supply must be installed to the latest I.E.E. regulations. If the unit is hard wired (moulded plug removed) it must be provided with a fused (5A) local isolator with a contact separation of 3mm minimum on all poles for servicing. Observe polarity and ensure that wiring is correctly restrained.

# INSTALLATION INSTRUCTIONS

## Single Infinity Direct Flow

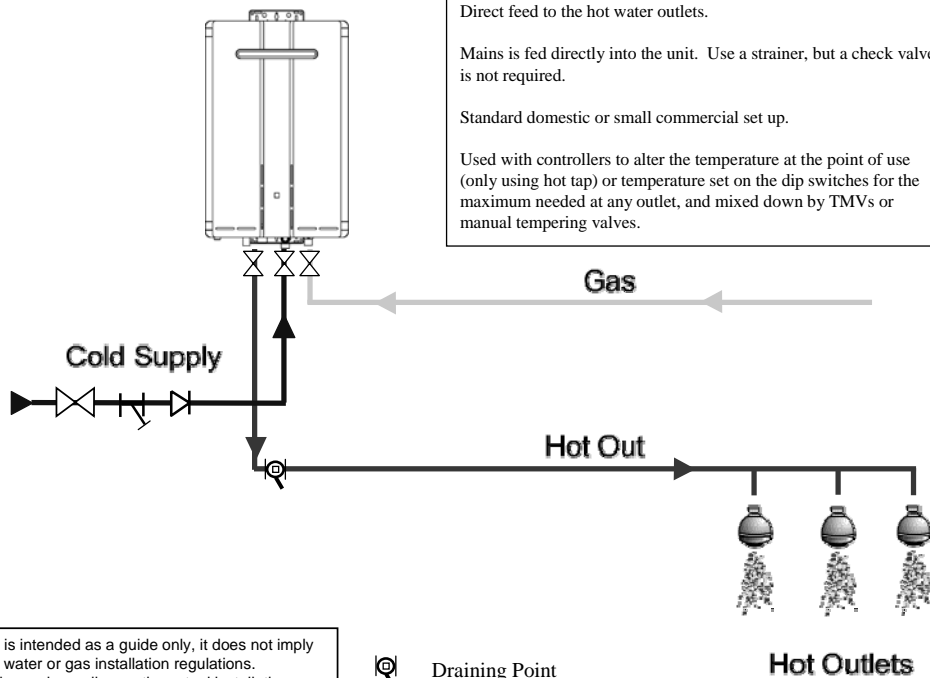

Direct feed to the hot water outlets.

Mains is fed directly into the unit. Use a strainer, but a check valve is not required.

Standard domestic or small commercial set up.

Used with controllers to alter the temperature at the point of use (only using hot tap) or temperature set on the dip switches for the maximum needed at any outlet, and mixed down by TMVs or manual tempering valves.

This information is intended as a guide only, it does not imply compliance with water or gas installation regulations. Components will vary depending on the actual installation. Check local regulations before installation.

## Manifolded Infinity x 2 With Pumped Secondary.

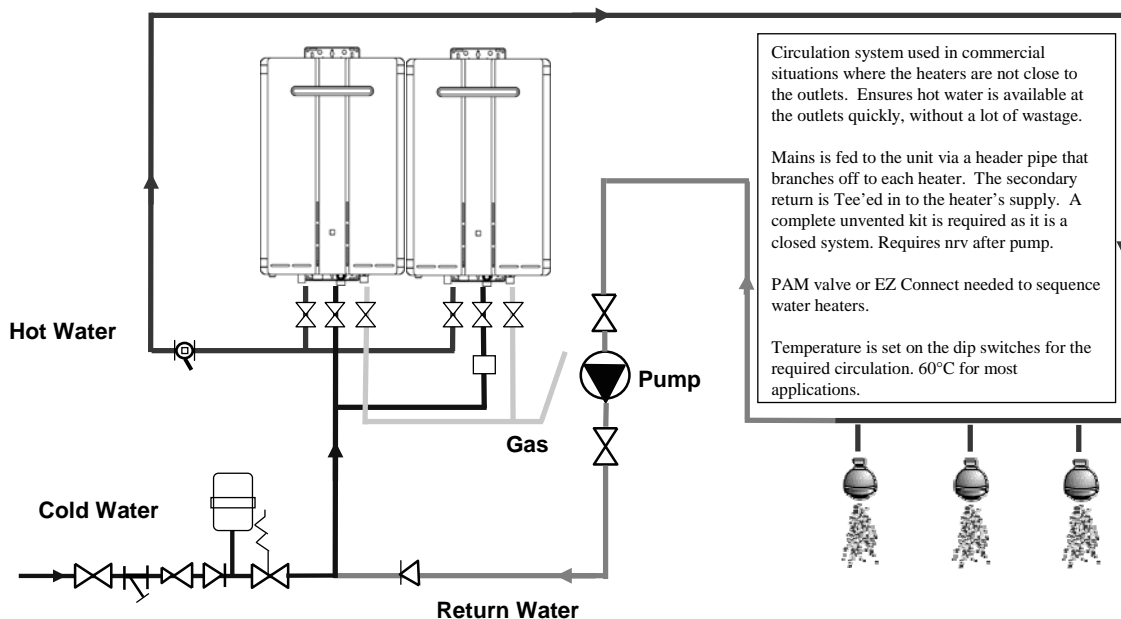

Circulation system used in commercial situations where the heaters are not close to the outlets. Ensures hot water is available at the outlets quickly, without a lot of wastage.

Mains is fed to the unit via a header pipe that branches off to each heater. The secondary return is Tee'ed in to the heater's supply. A complete unvented kit is required as it is a closed system. Requires nrv after pump.

PAM valve or EZ Connect needed to sequence water heaters.

Temperature is set on the dip switches for the required circulation. 60°C for most applications.

This information is intended as a guide only, it does not imply compliance with water or gas installation regulations. Components will vary depending on the actual installation. Check local regulations before installation.

Draining Point	Valve	Pressure Reducing Valve	Strainer	Non-Return Valve	Safety Valve	Expansion Vessel	Flow Modulation Valve

# UK INST. INSTRUCTIONS

## **General Information on the internal range of water heaters.**

The Rinnai Infinity internal water heaters are room sealed appliances. Ventilation requirements of BS 5440 allow room sealed appliances to be installed in spaces and rooms, including bedrooms, without ventilation.

If a Rinnai Infinity internal water heater is installed in a compartment it must have the following amount of permanent ventilation.

Ventilation from compartment to room:

560 cm<sup>2</sup> at high level AND  
560 cm<sup>2</sup> at low level

Based on 10cm<sup>2</sup>/kW net heat input

Ventilation from compartment directly to outside:

280 cm<sup>2</sup> at high level AND  
280 cm<sup>2</sup> at low level

Based on 5 cm<sup>2</sup>/kW net heat input

The area given is the free area of the vent or equivalent free area for ventilators of more complex design. Any space taken up by grille louvers should be subtracted from the total area to find the free area of the vent. For two heaters the area should be doubled, for three tripled, and so on.

Windows and doors can not be considered ventilation unless they are permanently fixed in the open position.

Please refer to IGE/UP/10 Part 1. Edition 2 page 17 for further information or contact Rinnai UK.

# FLUE REQUIREMENTS

**The flue must be installed by a competent, authorised person. It is the installer's responsibility to ensure that the unit has been installed to all current local requirements.**

Ensure that the flue terminal and hot water outlet connection cannot be touched by children. The flue must be clear of obstructions and shrubbery.

## **Concentric Flues**

The Rinnai Infinity Condensing water heaters internal units may only be installed with the approved Rinnai Infinity and HD flue kit provided. These instructions only apply to coaxial Rinnai Flues. If in doubt contact Rinnai UK.

The required clearance of the flue terminal is shown on page 31. When multiple units are installed together there must be enough clearance to satisfy the requirements of the regulations. Under current regulations the heaters should have at least a 100mm clearance between them. The flue terminal should be over 2m from ground level whenever possible. For lower installations a terminal guard cage must be installed.

## **Flue Length**

### Vertical Termination.

If the flue terminates vertically the maximum flue length is 9m. Maximum four bends 90° are permitted. For any 90° bend 2m must be subtracted from the maximum length (1m for each 45° bend). No more than four 90° bends are permitted.

### Horizontal Termination.

The maximum flue total equivalent length is 15m.

2m must be subtracted from the total equivalent length for each 90° bend and 1m for each 45° bend. A maximum of four 90° bends can be used. The maximum height of the terminal above the water heater is 9m.

## **Common Header (Cascade) Flues**

Do not connect this appliance into any common header flue, cascade system, or natural draught chimney. For information on these installations contact Rinnai.

Separate instructions are provided with the flue system detailing the installation of the flue components.

It is important that any condensate is kept away from the heat exchanger. The flue should tip away from the unit without a condensate trap, and towards the unit if there is a trap.

It is the responsibility of the installer to locate the appropriate place for the terminal.

The drain pipe should be run in 22mm PVC, uPVC, or ABS pipe, copper is not recommended. The drain pipe **MUST** be trapped.

## FLUE REQUIREMENTS

For the Rinnai Infinity Condensing internal water heaters the flue system is considered part of the continuous flow water heater. The following flue type and make is approved in combination with above mentioned water heaters.

Ubbink flue system:

184162 Rolux® condensing concentric roof terminal Ø 80/125 PP/Plastic T120°  
223124 Rolux® eccentric condensing wall terminal Ø 80/125 PP/Plastic T120° 800mm  
224077 Rolux® condensing concentric bend PP/Plastic Ø 80/125 45° T120°  
224078 Rolux® condensing concentric bend PP/Plastic Ø 80/125 87° T120°  
224087 Rolux® condensing concentric extension PP/Plastic Ø 80/125 250mm T120°  
224079 Rolux® condensing concentric extension PP/Plastic Ø 80/125 500mm T120°  
224080 Rolux® condensing concentric extension PP/Plastic Ø 80/125 1000mm T120°  
184176 Rolux® condensing concentric telescopic extension PP/Plastic Ø 80/125 T120°

Secure flue connections with pipe clamps or perforated hanger iron.  
Please see page 31 for recommended terminal positions.

### Warnings:

Before installation inspect each flue component for damage and correct seal placement. Do not attempt to fix or install any damaged component.

Improper installation of flue systems and components, or failure to follow all installation instructions can result in property damage or serious injury.

**The Rinnai Infinity Condensing internal water heater is for installation in conjunction with the Rinnai flue system.**

The flue must be installed in accordance with:

Manufacturers Installation Instructions  
British Standards including BS5440  
Gas Safety (Installation and Use) Regulations  
IGE/UP/10 Part1 Edition 2.  
Building Regulation J

Such other specifications and regulations that may supersede or complement the above documents.

**The flue must be installed by a competent, authorised person. It is the installer's responsibility to ensure that the unit has been installed to all current requirements.**

Location of the appliance flue terminal must be in accordance with the clearances shown in BS5440-1:2000. Table and Figure C.1 is provided for your guidance on page 30.

When multiple room sealed forced draught terminals are installed together there must be enough of a gap to satisfy the requirements of the regulations. Under current regulations the terminals must have at least a 300mm gap between them. The flue terminal should be over 2m from ground level whenever possible. For lower installations a terminal guard must be installed.

# UK FLUE REQUIREMENTS

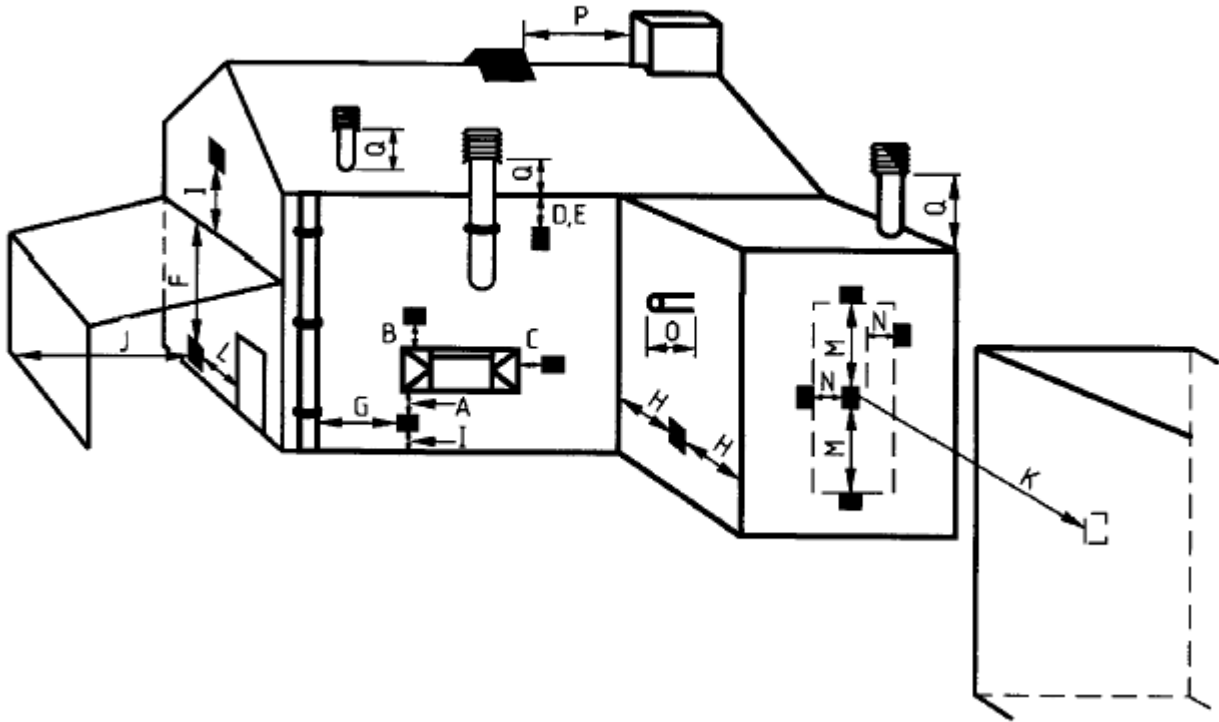

Dimension	Terminal Position	Distance
A	Directly below an opening, air brick, opening windows, etc.	300mm
B	Above an opening, air brick, opening window, etc.	300mm
C	Horizontally to an opening, air brick, opening window, etc.	300mm
D	Below gutters, soil pipes or drain pipes.	75mm
E	Below eaves.	200mm
F	Below balconies or car port roof.	200mm
G	From a vertical drain pipe or soil pipe.	150mm
H	From an internal or external corner.	200mm
I	Above ground, roof or balcony level.	300mm
J	From a surface facing the terminal.	600mm
K	From a terminal facing a terminal	1200mm
L	From an opening in a car port. ( eg door, window) into a dwelling	1200mm
M	Vertically from a terminal on the same wall.	1500mm
N	Horizontally from a terminal on the same wall.	300mm
O	From the wall on which the terminal is mounted	N/A
P	From a vertical structure on the roof.	N/A
Q	Above an intersection with roof.	N/A

# CONDENSATE DISPOSAL

The condensing unit generates condensate continuously at a rate of up to 5 litres per hour as a by-product of highly efficient gas burner system. This condensate must be drained via a pipe to a suitable point of discharge. Because the condensate is a by-product of a gas combustion it is mildly acid. For this reason copper tube and fittings **MUST NOT** be used as it will corrode. Instead, Rinnai recommend plastic pipes and fittings such as Unplasticised Polyvinyl Chloride (UPVC) or Polyethylene (PE) which is commonly used for irrigation piping.

## Important considerations for the Condensate Drain Pipe

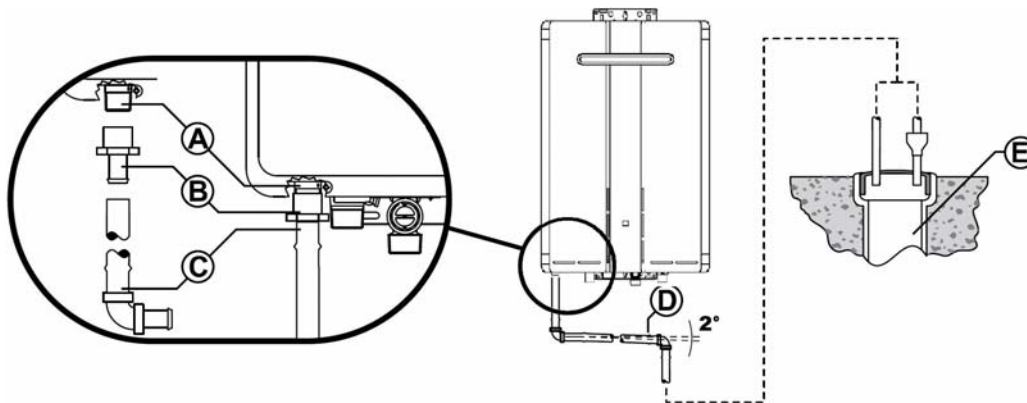

- (A) Water heater drain outlet connection, ½" (20mm) BSP male.
- (B) PE ½" BSP (20mm) female to barbed irrigation system connector (13 – 19mm) or equivalent plastic fitting.
- (C) Drain pipe and fittings to match item (B).
- (D) Continuous fall (of at least 2°) from water heater to discharge point. Lengths and bends in accordance with '**LENGTH AND CHANGES OF DIRECTION**' below.
- (E) Suitable points of discharge are deemed to be drains, sewers or pits. **DO NOT** discharge onto electrical connections, earth stakes, copper pipes, concrete paths or into a pond.

### LENGTH AND CHANGES OF DIRECTION

Maximum length and changes of direction greater than 45° should be as follows:

Lengths and changes of direction				
Max length (Metres)	9	8	7	6
Max changes of direction >45°	3	4	5	6

### INSTALLATION

- (a) The drain line **MUST NOT** discharge onto electrical connections, earth stakes, copper pipes, concrete paths or into a pond.
- (b) The point of discharge from each drain line shall be located so that the release of condensate does not cause a nuisance, is readily discernible and incurs no risk of damage to the building.

In view of (a) and (b), suitable points of discharge are deemed to be drains, sewers or pits.

- (c) There shall be no tap, valve or other restrictions in any line.
- (d) Each line shall fall continuously from the valve to the approved point of discharge.
- (e) Drain lines shall not discharge into a storage water heater safe tray.
- (f) The end of the condensate drain line shall be:
  - (i) not lower than 200 mm or higher than 300 mm above an unpaved surface; or
  - (ii) not lower than 75 mm or higher than 300 mm above a gravel pit not less than 100 mm in diameter in a paved surface.



# CONDENSATE DISPOSAL

- (g) Where discharging over a tundish or gully trap, drain lines shall have an air gap of a size at least twice the diameter of the drain line.

## **INTERCONNECTION OF CONDENSATE DRAIN LINES**

Condensate drain lines from multiple water heaters may be joined together provided they conform with the '**INSTALLATION**' requirements on previous page.

## **COMMON STACK DISCHARGE**

Where individual water heaters are installed in a multistorey building, the condensate drain lines may discharge into a common stack, subject to the following:

- (a) The discharge from the common stack is to a tundish, having a discharge line, that is not less than the size of the common stack, directly connected to a fixture trap, and installed in connection with any adjacent soil or waste stack.
- (b) The discharge point of the common stack is such that any discharge is readily visible and not cause any nuisance.
- (c) The common stack is vented by extending the pipe upwards, above the roof level.

## **TUNDISH DRAIN LINES**

The drain line from any tundish shall be not less than DN 20 or less than one size larger than that of the largest drain line discharging into the tundish. Tundish drain lines shall comply with the '**INSTALLATION**' requirements on previous page.

## **AREAS SUBJECT TO FREEZING**

In areas where water pipes are prone to freezing, the drain pipe from any valve shall be insulated and not exceed 300 mm in length. It shall discharge into a tundish through an air gap of not less than 75 mm and not more than 150 mm measured from the outlet of the drain pipe to the rim of the tundish.

# TEMPERATURE CONTROLS

## General Information

Commercial installations do not generally have controllers installed. These installations usually have one permanent set temperature that is constant at all times. The public should not have access to alter the temperature in these situations. These installations do not require controllers as the temperature can be set by a series of dip switches on the PCB.

Exceptions to this are the following:

1. Circumstances where the required temperature is not available with the dip switches (for example 41°C or 47°C).
2. Circumstances where the temperature needs to be raised periodically by the building occupant in order to flush the system.
3. Domestic situations where the user needs control of the temperature of the water so that different temperatures can be used at different outlets.

In situations such as 1 and 2 the controllers should be installed in places out of reach of the public, such as in the maintenance room or in a locked cupboard.



This **Commercial Setting** will allow the controller to come back on automatically after a power cut at the temperature setpoint previous to the power cut, regardless of whether water is flowing through the unit. This should only be used for commercial installations.

### NEW FEATURE

The maximum temperature available on the Primary Universal Remote Controller is the set point on the dip switches. If only one controller is installed it will not go beyond 50°C when first installed. To bypass this see page 11.

Positioning the temperature controls, the following points should be taken into account:

- Fit the controls out of reach of children (suggested height from the floor 1.5m).
- Avoid positions where the controllers will become hot. Do not fit them near stoves or ovens, or above radiators or heaters.
- If possible, avoid exposure to direct sunlight or positions where bright lights will make the digital display difficult to read.
- Position away from areas where the controller will be prone to splashing by cooking products such as oils and fats.
- The temperature controllers are water resistant, however they should be positioned away from areas where direct or persistent splashing could occur.
- Refer to the local electrical wiring regulations current edition for location requirements in shower and bath areas.
- The cables to the temperature controller carry only 12VDC (extra low voltage).
- When using more than one temperature controller the signal cable should be run in parallel. Do not wire the controllers in series.

The installation in every application will vary, therefore the temperature controller cable has been provided so that you may cut the length accordingly and fit the spade connectors, ensuring a good connection.

Cables are simply 'piggy-backed' at the water heater or at the primary temperature controller. Polarity is not important when connecting the cables, either colour wire can be connected to either terminal at both the heater or primary temperature controller. If more cable is needed any cable with similar specification to the cable supplied with the controller can be used. Maximum length is 50 metres.

### Controller Connection in Parallel

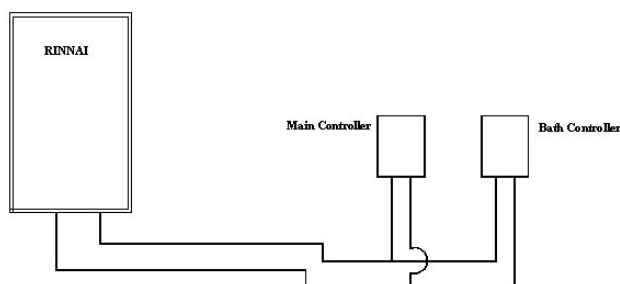

# TEMPERATURE CONTROLS

## Universal Temperature Controller - MC-91

1. Determine the most suitable position for the temperature controller.
2. Drill 3 holes in the wall (Fig.1), one for the cable and two for the securing screws. Fit wall plugs if needed and ensure controller is level.
3. Run the cable provided through the hole in the wall ensuring that the end fitted with the connector is nearest the controller (Fig.2).
4. Remove the face plate from the controller using a flat screwdriver (Fig.3). Take care not to damage the cover.
5. Connect the cable to the temperature controller.
6. Fix the controller to the wall and fasten with the Phillips head screws supplied as shown in (Fig.4).
7. Remove the protective plastic film from the controller face.
8. Replace the face plate.

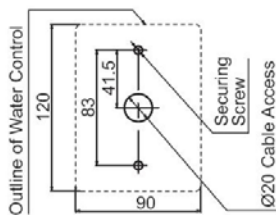

Fig. 1

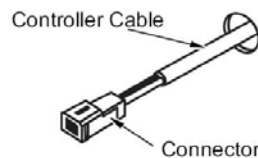

Fig. 2

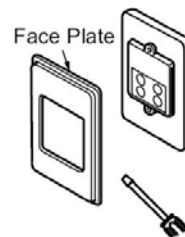

Fig. 3

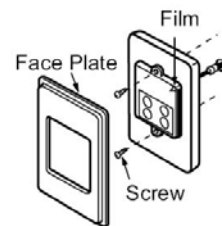

Fig. 4

## Connecting One or Two Controllers

1. Isolate the electric power supply.
2. Remove the retaining screw of the quick cable connector door located at the base of the appliance (Fig.5).
3. Thread the water controller cable through the weather seal of the cable access hole (A) (Fig.6) in the direction shown allowing sufficient cable length so that the sheath of the cable can be secured with cable clamp (B) supplied with the water controllers (Fig.7).
4. Loosen the screws on terminals (C) and (D). Connect the spade connectors of the controller cables to these terminals. Tighten the screws on terminals (C) and (D). Polarity is not important, either wire colour can be connected to either terminal (Fig.8).
5. Return the quick cable connector door to the original position taking care not to damage controller wires and replace the retaining screw.

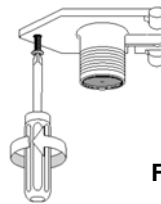

Fig.5

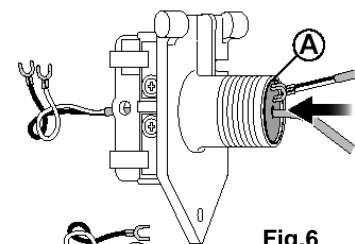

Fig.6

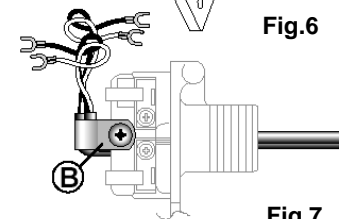

Fig.7

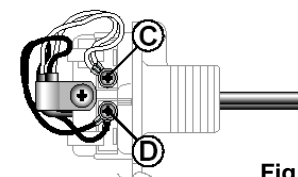

Fig.8

## Connecting Three Controllers

Repeat steps 1, 2 and 3 above.

- Cut the spade connectors from two of the controller cables to be connected to the appliance (4 spade connectors should be cut off) and discard. Connect the wires from these two cables and terminate into two new spade connectors as shown in Fig.9. Spade connectors are supplied with the controllers.

Repeat steps 4 and 5 above.

## Connecting Four Controllers

Repeat steps 1, 2 and 3 above.

- Cut the spade connectors from all four of the controller cables to be connected to the appliance (8 spade connectors should be cut off) and discard. Connect the wires of two cables and terminate into two new spade connectors as shown in Fig.9. Repeat this for the remaining two cables. Spade connectors are available from your local electrical component retailer.

Repeat steps 4 and 5 above.

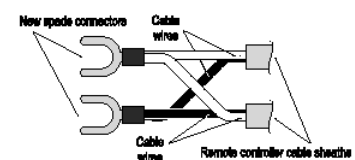

Fig.9

# EZ CONNECT



## NEW FEATURE

### EZ Connect Installation

The EZ Connect allows the installation of two Infinity water heaters to be controlled by one remote controller without PAM valves or a MECS. This will allow temperature control through use of a single remote, while error messages will be displayed on the status monitor. The EZ Connect will sequence the heaters for low flows and rotate the lead heater for even use.

#### Installing the EZ Connect

1. Install the two Infinity water heaters from 50mm to 450mm apart so that the EZ Connect cable will reach between the two. More than 450mm apart can cause temperature fluctuations.
2. Remove the protective cap from the 3 pin connector marked EZ Connect located in the wiring harness of the Primary Unit (Fig.1).

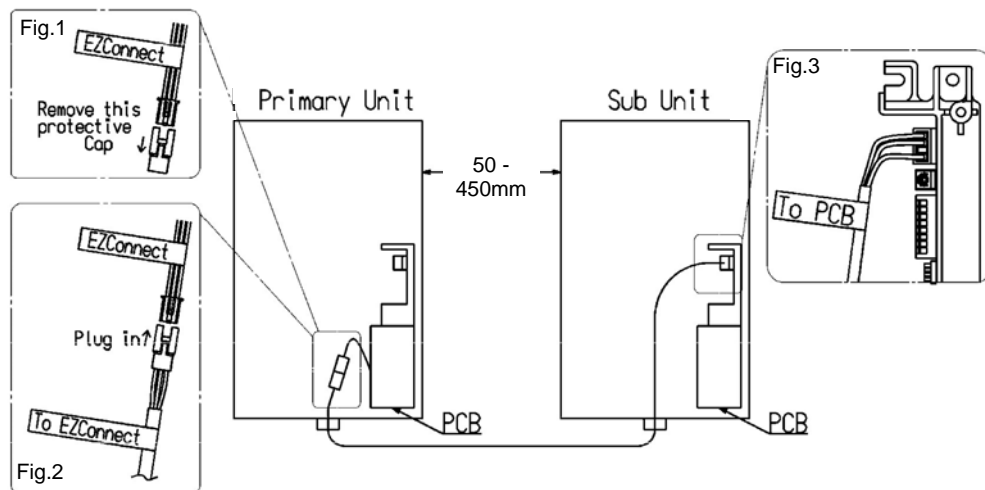

3. Plug in the EZ Connect cable. The end marked To EZ Connect connects in the primary Infinity water heater to the 3 pin connector seen in Fig. 2. The other end, marked To PCB, connects to the empty plug at the top of the PCB of the other water heater (sub unit). (Fig. 2 and 3)
4. Securely fasten the EZ Connect cable to the bottom of each Infinity water heater with the cable clamps and screws supplied. (Fig. 4)



#### NOTE

- The EZ Connect cannot be used with the MECS.
- The EZ Connect cannot use the Bath Fill Function.
- The temperature can only be changed on the primary unit's controller.
- PAM valves are not required.

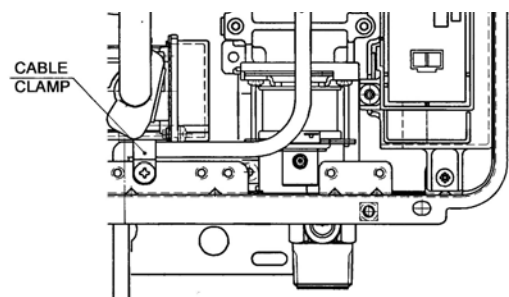

Fig. 4

# TESTING



1. Purge gas, hot water and cold water supply lines before making the final connection of the water heater. Swarf in either the gas or water supplies may cause damage.
2. Turn on gas and cold water supplies.
3. Test for water leaks and gas escapes near the unit.
4. Isolate gas and electric supply. Remove test point screw located on the inlet gas pipework below the heater and attach pressure gauge.
5. Turn the power on at the switch and turn on gas. **Warning:** There are 230V AC live supplies inside the heater.
6. If remote controllers are fitted, turn the controller on, select the maximum delivery temperature and open ALL available hot water outlets. If remote controllers are not fitted, simply open all available hot water outlets. (CAUTION: Ensure building occupants do not have access to hot water outlets during this procedure).
7. The gas pressure check must be carried out with all other appliances on the same main operating at maximum capacity to ensure that there is sufficient gas pressure.
8. With all appliances on the same main operating at high fire check the pressure at the test point on the inlet to the gas valve. The pressure must be within the local defined limits for the type of gas that is being used. If the pressure is lower, the gas supply is inadequate and the water heater will not operate to specification. Check gas meter, regulator and pipework for correct operation/sizing and rectify as required. Note that the gas regulator on the appliance is electronically controlled and factory pre-set. Under normal circumstances it does not need adjustment during installation.  
  
**UK:** the gas pressure must be at least **20 mbar** and no more than **21 mbar** for G20 Natural Gas as used in UK. For G31 Propane as used in the UK the pressure must be at least **34.5 mbar** and no more than **37 mbar**.
9. Close hot water outlets.
10. Inspect and clean the strainer and the filter located on the cold water inlet pipe. This procedure may need to be repeated to ensure the strainer remains clear.
11. If temperature controllers are fitted, it is necessary to test their operation through the complete range of functions.
12. Confirm the hot water delivery temperature using a thermometer. If controllers are fitted, compare the measured value to the set point.
13. After testing is completed, explain to the user the functions and operation of the water heater and temperature controllers.

# GAS PRESSURE SETTING

The working gas pressure on the water heater is electronically controlled and factory set. Under normal circumstances it **does not** require adjustment during installation. The pressure should be checked when the unit is installed and each time it is serviced to ensure that it is correct. **Contact Rinnai before attempting to alter the gas pressure if you are unsure of what to do. Incorrect adjustment can void the warranty.**

1. Turn 'OFF' the gas supply.
2. Turn 'OFF' 230V power supply.
3. Remove the front cover from the appliance.
4. Check gas type dip switch no.1 of SW2 is in the correct position for the type of gas (Nat. or LPG)\* you are using. See Fig. 1

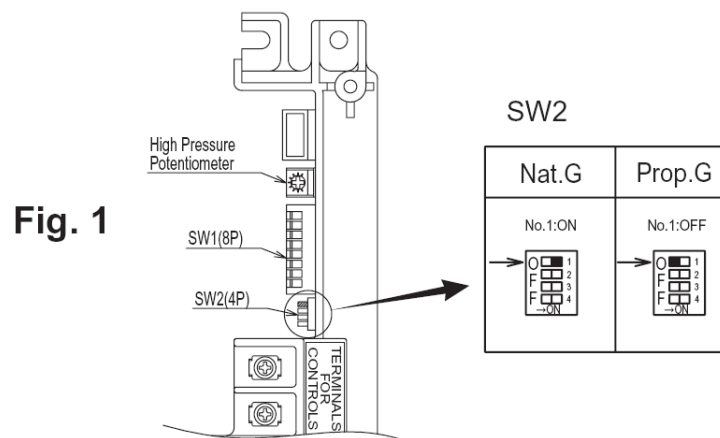

5. Attach pressure gauge to burner test point. (Fig. 2)

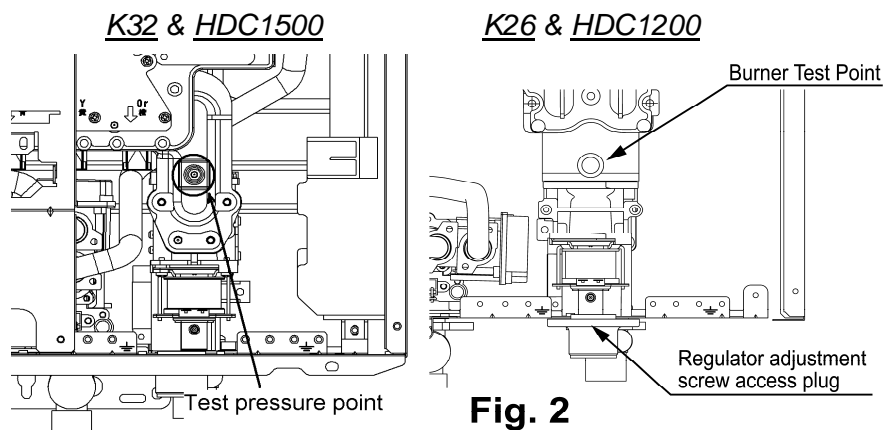

6. Turn 'ON' the gas supply.
7. Turn 'ON' 230V power supply.
8. If remote controllers are fitted, turn the unit 'ON' at the controller and select a maximum delivery temperature.
9. Open a hot water tap fully. (**CAUTION: Ensure building occupants do not have access to hot water outlets during this procedure.**) Wait for the unit to light.



\* Simply changing the position of the dip switches will not convert the unit from one gas type to the other. The conversion procedure requires a change of injector manifold. Contact Rinnai or your supplier.

# GAS PRESSURE SETTING

10. Set the Rinnai Infinity to 'Forced Low' combustion by setting No. 7 dipswitch of SW1 to 'ON'. (Fig. 3)

11. Check the burner test point operating pressure.

LOW	External		Internal			
		32	26		32	26
NG	G20	1.81	1.47	G20	2.26	1.76
	G25	2.35	2.11	G25	2.81	2.19
LPG	G30	2.65	2.46	G30	3.19	2.47
	G31	2.65	2.46	G31	3.19	2.47

*(pressures in mbar)*

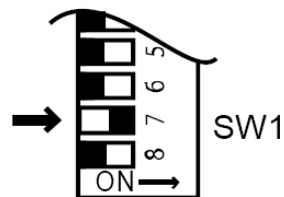

**Fig. 3**

12. Remove rubber access plug and adjust the regulator screw on the modulating valve (Fig. 4) as required to the pressure above. Replace rubber access plug and seal it shut.

13. Set the Rinnai Infinity to 'Forced High' combustion by setting No. 7 and No. 8 dipswitches to 'ON' (Fig.5). Ensure maximum water flow.

14. Check the burner test point pressure.

HIGH	External		Internal			
		32	26		32	26
NG	G20	5.64	6.78	G20	6.28	7.51
	G25	7.40	9.68	G25	8.00	10.32
LPG	G30	7.99	8.51	G30	9.02	9.51
	G31	7.99	8.51	G31	9.02	9.51

*(pressures in mbar)*

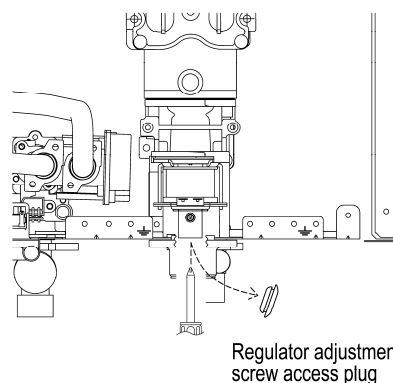

**Fig. 4**

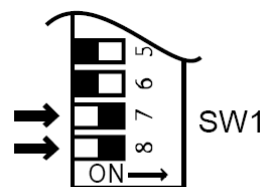

**Fig. 5**

15. Adjust the **High Pressure Potentiometer** on the Printed Circuit Board above SW1 (Fig. 6) to the pressure shown above. The potentiometer is very sensitive, turn no more than a few degrees at a time; then let the pressure settle down before turning it more. Seal screw shut.

16. **IMPORTANT:** Set dip switch No. 7 and No. 8 of SW1 to 'OFF' to return the appliance to 'Normal' combustion.

17. Close hot water tap and turn 'OFF' the gas supply and 230V power supply.

18. Remove pressure gauge and replace sealing screw. Turn 'ON' the gas supply and power.

19. Operate unit and check gas leaks.

20. Replace the front cover of the appliance.

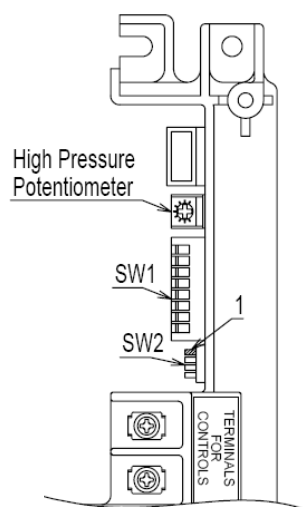
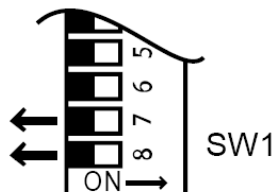

**Fig. 6**

# DIP SWITCH SETTING

## Dip Switch Positions Explained

OFF	ON	SW1	
<input type="checkbox"/>	<input type="checkbox"/>	1	- Flue Length
<input type="checkbox"/>	<input type="checkbox"/>	2	- Temperature
<input type="checkbox"/>	<input type="checkbox"/>	3	- Temperature
<input type="checkbox"/>	<input type="checkbox"/>	4	- Temperature
<input type="checkbox"/>	<input type="checkbox"/>	5	- Temperature
<input type="checkbox"/>	<input type="checkbox"/>	6	- Computer Programming
<input type="checkbox"/>	<input type="checkbox"/>	7	- Forced Combustion
<input type="checkbox"/>	<input type="checkbox"/>	8	- Forced Combustion

OFF	ON	SW2	
<input type="checkbox"/>	<input type="checkbox"/>	1	- Gas Type
<input type="checkbox"/>	<input type="checkbox"/>	2	- Gas Type
<input type="checkbox"/>	<input type="checkbox"/>	3	- Model Choice
<input type="checkbox"/>	<input type="checkbox"/>	4	- Model Choice
<input type="checkbox"/>	<input type="checkbox"/>	5	- Commercial Setting
<input type="checkbox"/>	<input type="checkbox"/>	6	- External Device Selection

### LEGEND:

Black Section indicates position of dip switch.

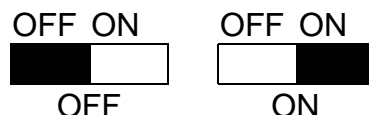

### COMPUTER PROGRAMMING

OFF	ON	SW1	
<input type="checkbox"/>	<input type="checkbox"/>	5	<u>Dip SW 6</u>
<input checked="" type="checkbox"/>	<input type="checkbox"/>	6	of SW1 is
<input type="checkbox"/>	<input type="checkbox"/>	7	always
<input type="checkbox"/>	<input type="checkbox"/>	8	set OFF
			position

## Dip Switches Explained

### GAS TYPE

LPG			NATURAL GAS		
OFF	ON	SW2	OFF	ON	SW2
<input checked="" type="checkbox"/>	<input type="checkbox"/>	1	off	<input type="checkbox"/>	1 on
<input type="checkbox"/>	<input type="checkbox"/>	2	off	<input checked="" type="checkbox"/>	2 off
<input type="checkbox"/>	<input type="checkbox"/>	3		<input type="checkbox"/>	3

### MODEL

OFF	ON	SW2	
<input type="checkbox"/>	<input type="checkbox"/>	1	<u>Dip SW 3</u> of SW2 is:
<input type="checkbox"/>	<input type="checkbox"/>	2	ON for 26 litres
<input checked="" type="checkbox"/>	<input type="checkbox"/>	3	OFF for 32 litres
<input type="checkbox"/>	<input type="checkbox"/>	4	<u>Dip SW 4</u> of SW2 is:
<input type="checkbox"/>	<input type="checkbox"/>	5	ON for "internal" models
<input type="checkbox"/>	<input type="checkbox"/>	6	OFF for "external" models

### COMMERCIAL SETTING

OFF	ON	SW2	
<input type="checkbox"/>	<input type="checkbox"/>	1	
<input type="checkbox"/>	<input type="checkbox"/>	2	<u>Dip SW 5</u>
<input type="checkbox"/>	<input type="checkbox"/>	3	OFF for Domestic Installations;
<input type="checkbox"/>	<input type="checkbox"/>	4	ON for Commercial Installations.
<input checked="" type="checkbox"/>	<input checked="" type="checkbox"/>	5	
<input type="checkbox"/>	<input type="checkbox"/>	6	

## FORCED COMBUSTION

### NORMAL

OFF	ON	SW1	
<input checked="" type="checkbox"/>	<input type="checkbox"/>	7	off
<input type="checkbox"/>	<input type="checkbox"/>	8	off

### FORCED LOW

OFF	ON	SW1	
<input type="checkbox"/>	<input checked="" type="checkbox"/>	7	on
<input checked="" type="checkbox"/>	<input type="checkbox"/>	8	off

### FORCED HIGH

OFF	ON	SW1	
<input type="checkbox"/>	<input checked="" type="checkbox"/>	7	on
<input type="checkbox"/>	<input checked="" type="checkbox"/>	8	on

### FLUE LENGTH

(OFF for External models)

OFF	ON	SW1	
<input checked="" type="checkbox"/>	<input checked="" type="checkbox"/>	1	
			ON for short flues (< 7m)
			OFF for long flues (>7m)
			Total Equivalent Length



# DIP SWITCH SETTING

Infinity K32i / K32e / K26i / K26e / HDC1500i / HDC1500e / HDC1200i / HDC1200e

## Temperatures - With or Without Remotes Connected

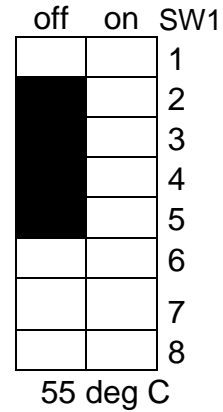
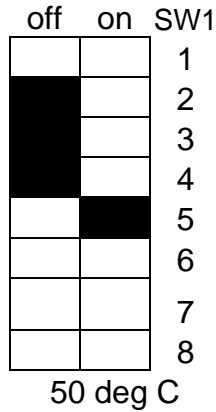
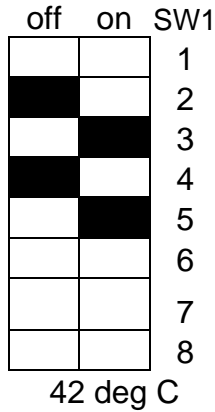
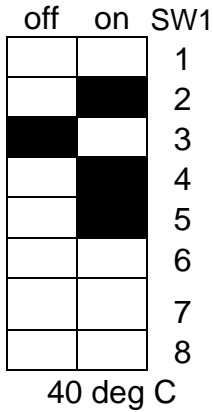

(Infinity factory setting)

HDC1500i - HDC1500e - HDC1200i - HDC1200e

## Temperatures - Remotes Connected

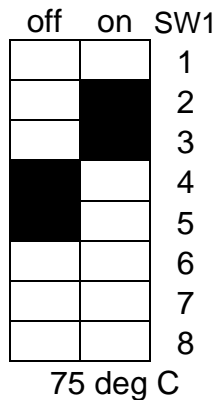
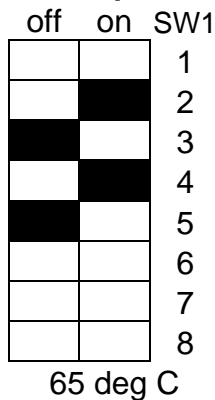
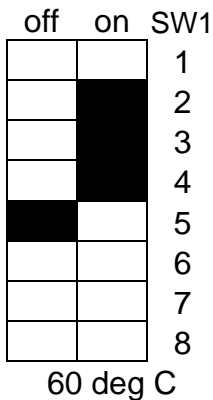

If the remote is accidentally disconnected the unit would revert to 55°C

HDC1500i - HDC1500e - HDC1200i - HDC1200e

## Temperatures - Remotes Not Connected

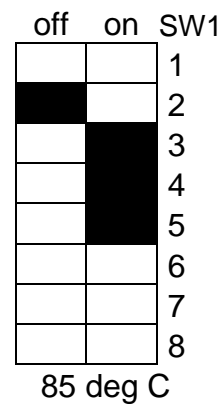
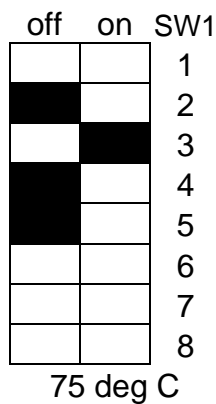
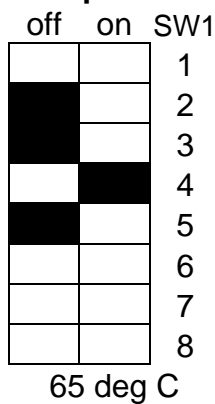
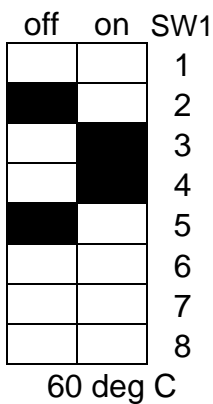

(HD factory setting)

# DIMENSIONS

## Infinity K32i and HDC1500i

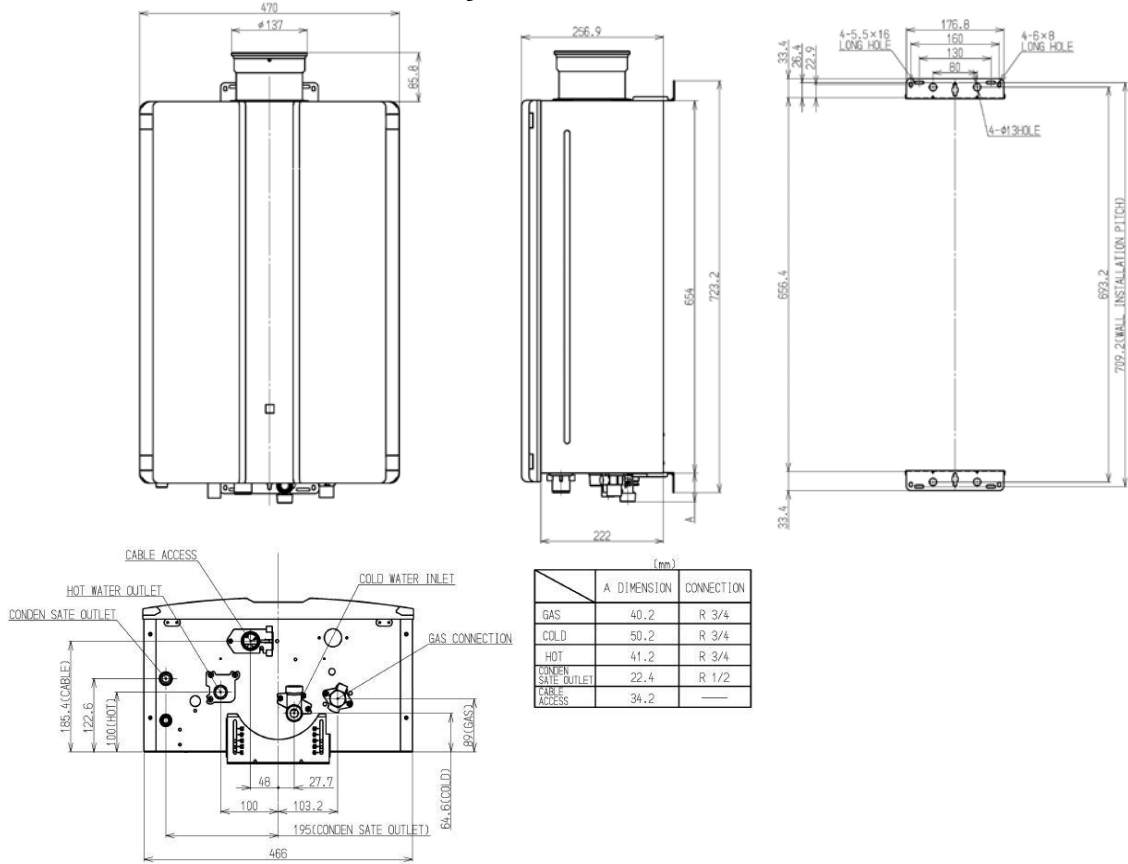

## Infinity K32e and HDC1500e

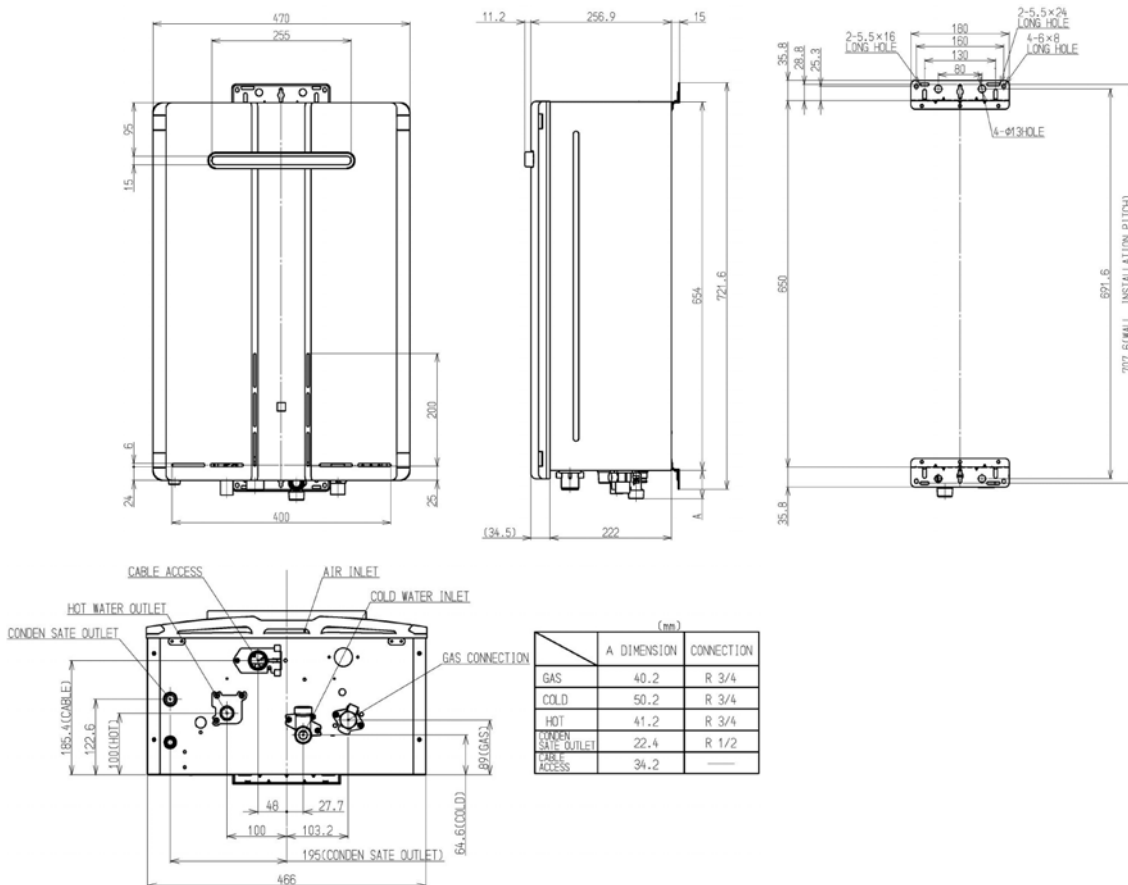

# DIMENSIONS

## Infinity K26i and HDC1200i

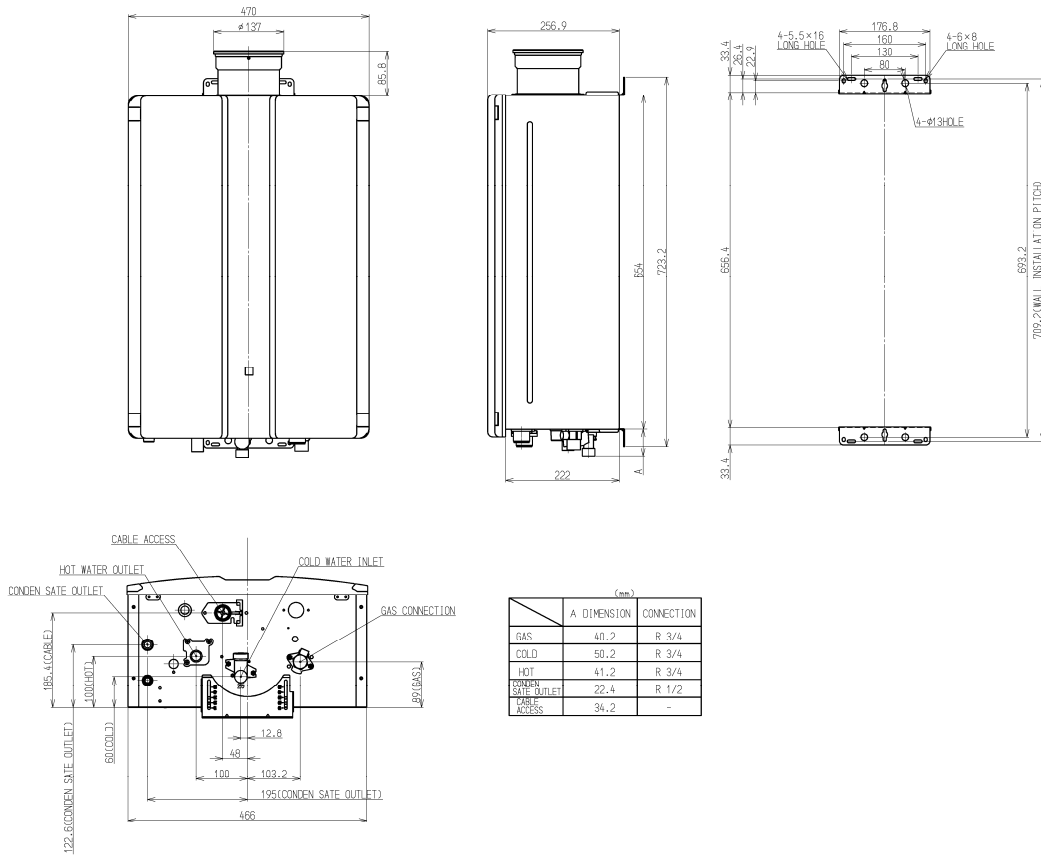

## Infinity K26e and HDC1200e

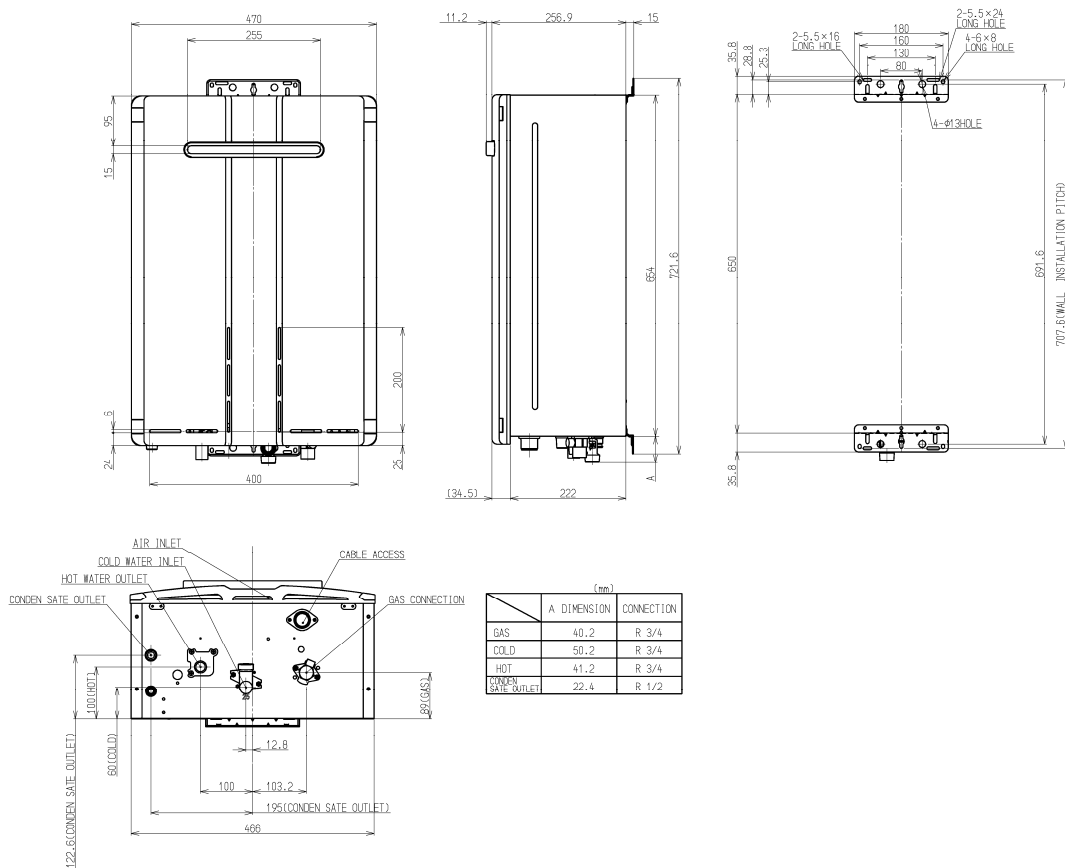

# TECHNICAL DETAILS

Infinity Model	Inf. K32e / HDC1500e	Inf. K32i / HDC1500i	Units
Installation	External	Internal	
G20 Nat Gas Press Low	1.81	2.26	mbar
G20 Nat Gas Press High	5.64	6.28	mbar
G25 Nat Gas Press Low	2.35	2.81	mbar
G25 Nat Gas Press High	7.40	8.00	mbar
G31 Propane / G30 Butane Press Low	2.65	3.19	mbar
G31 Propane / G30 Butane Press High	7.99	9.02	mbar
Flue System	Direct Forced Exhaust	Forced, Room Sealed	
Temp. Range Controllers	37-46,48,50,55 - Infinity Range (plus 60,65,75 - HDC)		°C
Temp. via dip switches	40, 42, 50, 55, 60, 65, 75, 85		°C
Ignition	Direct Electronic Ignition		
<u>Gas Consumption &amp; Capacities <b>min</b> conditions</u>	H <sub>i</sub> = net calorific value H <sub>s</sub> = gross calorific value		
G20 Nat Gas: Input Q <sub>m</sub> : Hi/Hs   Useful output P <sub>m</sub>	2.55/2.83   2.27	2.55/2.83   2.27	kW
G20 Nat Gas flow V	0.27	0.27	m <sup>3</sup> /hr
G25 Nat Gas: Input Q <sub>m</sub> : Hi/Hs   Useful output P <sub>m</sub>	2.55/2.83   2.27	2.55/2.83   2.27	kW
G25 Nat Gas flow ref. conditions V <sub>r</sub>	0.31	0.31	m <sup>3</sup> /hr
G30 Input Q <sub>m</sub> : Hi/Hs   Useful output P <sub>m</sub>	3.17/3.44   2.75	3.17/3.44   2.75	kW
G30 flow normal operating conditions M <sub>m</sub>	0.25	0.25	Kg./hr
G31 Input Q <sub>m</sub> : Hi/Hs   Useful output P <sub>m</sub>	2.78/3.02   2.42	2.78/3.02   2.42	kW
G31 flow normal operating conditions M <sub>m</sub>	0.22	0.22	Kg./hr
<u>Gas Consumption &amp; Capacities <b>nominal</b> condit.</u>	H <sub>i</sub> = net calorific value H <sub>s</sub> = gross calorific value		
G20 Nat Gas: Input Q <sub>n</sub> : Hi/Hs   Useful output P <sub>n</sub>	53.6/59.5   56	53.6/59.5   56	kW
G20 Nat Gas flow ref. conditions V <sub>r</sub>	5.7	5.7	m <sup>3</sup> /hr
G25 Nat Gas: Input Q <sub>n</sub> : Hi/Hs   Useful output P <sub>n</sub>	53.6/59.5   56	53.6/59.5   56	kW
G25 Nat Gas flow ref. conditions V <sub>r</sub>	6.6	6.6	m <sup>3</sup> /hr
G30 Input Q <sub>n</sub> : Hi/Hs   Useful output P <sub>n</sub>	61.7/67.06   62.2	61.7/67.06   62.2	kW
G30 flow normal operating conditions M <sub>n</sub>	4.87	4.87	Kg./hr
G31 Input Q <sub>n</sub> : Hi/Hs   Useful output P <sub>n</sub>	54.1/58.8   54.7	54.1/58.8   54.7	kW
G31 flow normal operating conditions M <sub>n</sub>	4.2	4.2	Kg./hr
Country of destination	GB/IE		
Gas category and pressure	I <sub>2H</sub> G20-20mbar / I <sub>2L</sub> G25-25mbar / I <sub>3P</sub> G31-37mbar		
Type	A3 Outdoor	C13/33	
Max Flow ( delta T = 21° K )	37	37	L/min
Min Operation Flow	1.5*	1.5*	L/min
Water Pressure (P <sub>w</sub> )	1.0* - 10.0 (recommend 2.0 min.)		bar
Power Supply	230 V / 50 Hz		
Electric Consumption (1 remote)	72	99	Watts
Noise Level	50		dB (A)
Ignition safety time T <sub>SAmax</sub>	4.2		Sec.

\* Minimum operation pressure and flow based on temperature setpoint and inlet conditions.

# TECHNICAL DETAILS

Infinity Model	Inf. K26e / HDC1200e	Inf. K26i / HDC1200i	Units
Installation	External	Internal	
G20 Nat Gas Press Low	1.47	1.76	mbar
G20 Nat Gas Press High	6.78	7.51	mbar
G25 Nat Gas Press Low	2.11	2.19	mbar
G25 Nat Gas Press High	9.68	10.32	mbar
G31 Propane / G30 Butane Press Low	2.46	2.47	mbar
G31 Propane / G30 Butane Press High	8.51	9.51	mbar
Flue System	Direct Forced Exhaust	Forced, Room Sealed	
Temp. Range Controllers	37-46,48,50,55 - Infinity Range (plus 60,65,75 - HDC)		°C
Temp. via dip switches	40, 42, 50, 55, 60, 65, 75, 85		°C
Ignition	Direct Electronic Ignition		
<u>Gas Consumption &amp; Capacities <b>min</b> conditions</u>	H <sub>i</sub> = net calorific value H <sub>s</sub> = gross calorific value		
G20 Nat Gas: Input Q <sub>m</sub> : Hi/Hs   Useful output P <sub>m</sub>	2.55/2.83   2.27	2.55/2.83   2.27	kW
G20 Nat Gas flow V	0.27	0.27	m <sup>3</sup> /hr
G25 Nat Gas: Input Q <sub>m</sub> : Hi/Hs   Useful output P <sub>m</sub>	2.55/2.83   2.27	2.55/2.83   2.27	kW
G25 Nat Gas flow ref. conditions V <sub>r</sub>	0.31	0.31	m <sup>3</sup> /hr
G30 Input Q <sub>m</sub> : Hi/Hs   Useful output P <sub>m</sub>	3.17/3.44   2.75	3.17/3.44   2.75	kW
G30 flow normal operating conditions M <sub>m</sub>	0.25	0.25	Kg./hr
G31 Input Q <sub>m</sub> : Hi/Hs   Useful output P <sub>m</sub>	2.78/3.02   2.42	2.78/3.02   2.42	kW
G31 flow normal operating conditions M <sub>m</sub>	0.22	0.22	Kg./hr
<u>Gas Consumption &amp; Capacities <b>nominal</b> condit.</u>	H <sub>i</sub> = net calorific value H <sub>s</sub> = gross calorific value		
G20 Nat Gas: Input Q <sub>n</sub> : Hi/Hs   Useful output P <sub>n</sub>	43.5/48.31   45.9	43.5/48.31   45.9	kW
G20 Nat Gas flow ref. conditions V <sub>r</sub>	4.60	4.60	m <sup>3</sup> /hr
G25 Nat Gas: Input Q <sub>n</sub> : Hi/Hs   Useful output P <sub>n</sub>	43.5/48.32   45.9	43.5/48.32   45.9	kW
G25 Nat Gas flow ref. conditions V <sub>r</sub>	5.35	5.35	m <sup>3</sup> /hr
G30 Input Q <sub>n</sub> : Hi/Hs   Useful output P <sub>n</sub>	49.9/54.08   52.7	49.9/54.08   52.7	kW
G30 flow normal operating conditions M <sub>n</sub>	3.94	3.94	Kg./hr
G31 Input Q <sub>n</sub> : Hi/Hs   Useful output P <sub>n</sub>	43.8/47.61   46.2	43.8/47.61   46.2	kW
G31 flow normal operating conditions M <sub>n</sub>	3.40	3.40	Kg./hr
Country of destination	GB/IE		
Gas category and pressure	I <sub>2H</sub> G20-20mbar / I <sub>2L</sub> G25-25mbar / I <sub>3P</sub> G31-37mbar		
Type	A3 Outdoor	C13/33	
Max Flow ( delta T = 21° K )	35	35	L/min
Min Operation Flow	1.5*	1.5*	L/min
Water Pressure (P <sub>w</sub> )	1.0* - 10.0 (recommend 2.0 min.)		bar
Power Supply	230 V / 50 Hz		
Electric Consumption (1 remote)	72	99	Watts
Noise Level	50		dB (A)
Ignition safety time T <sub>SAmax</sub>	4.2		Sec.

\* Minimum operation pressure and flow based on temperature setpoint and inlet conditions.

# FLOW CHART

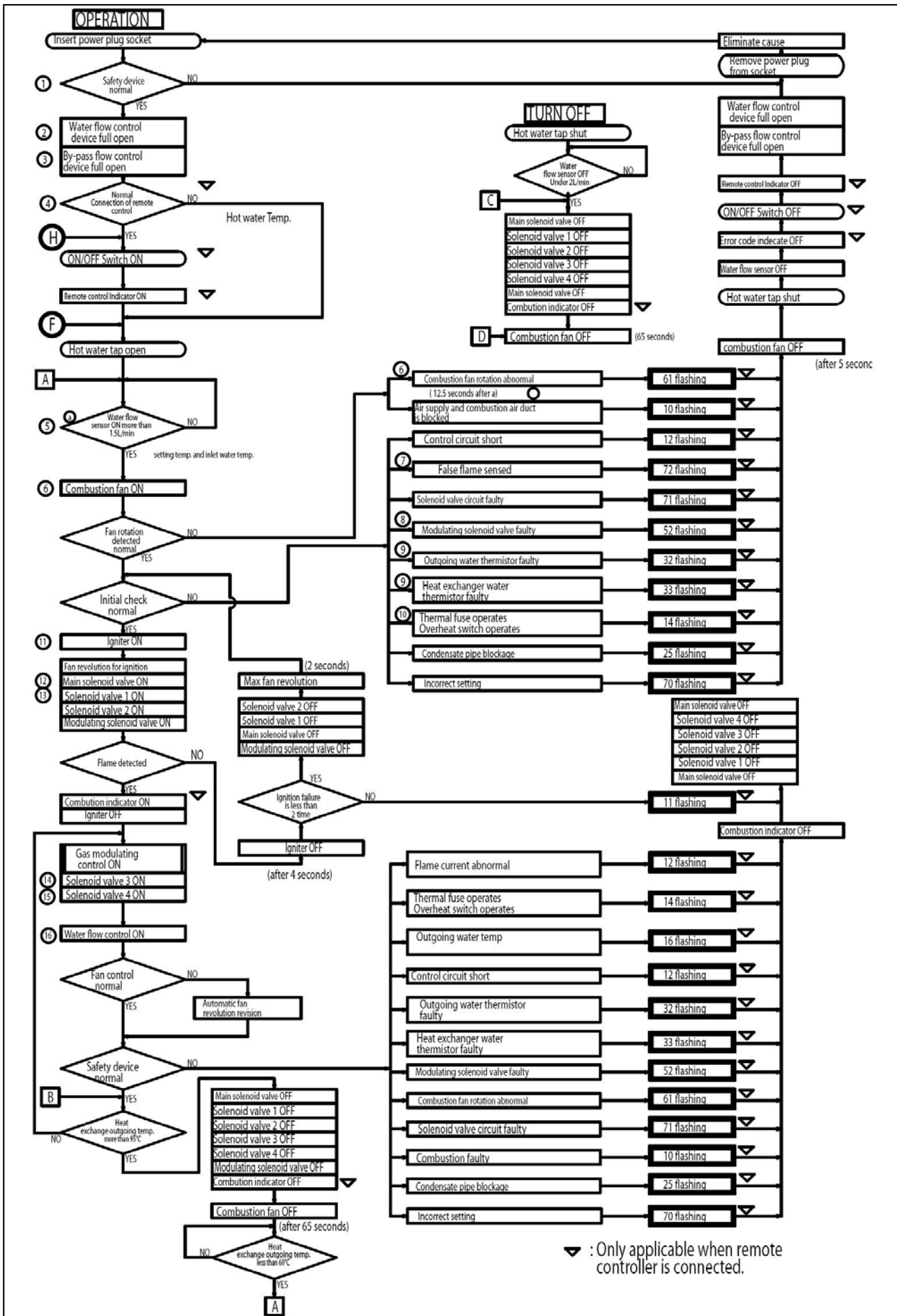

# WIRING DIAGRAM

## Infinity K32

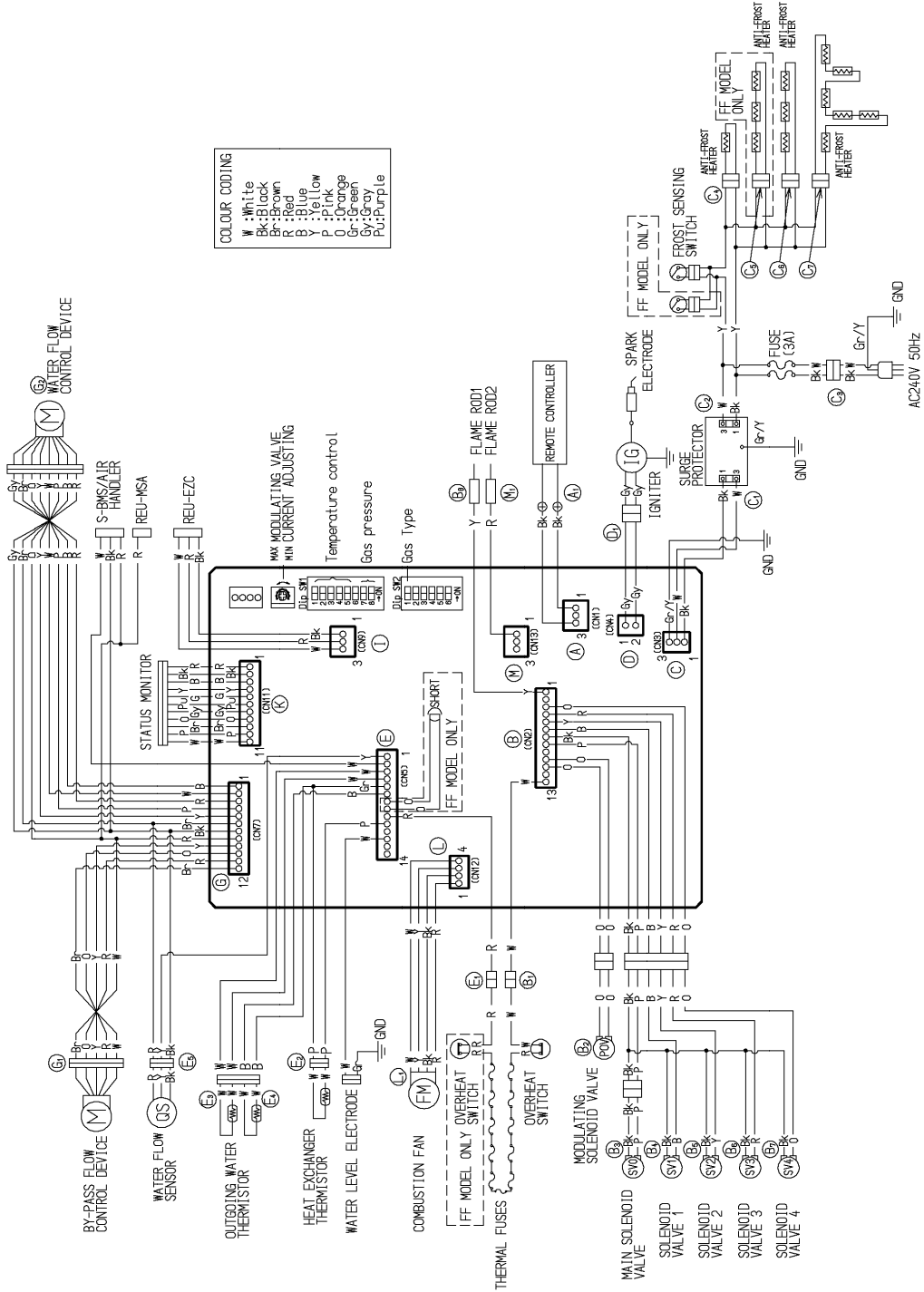

# WIRING DIAGRAM

## Infinity K26

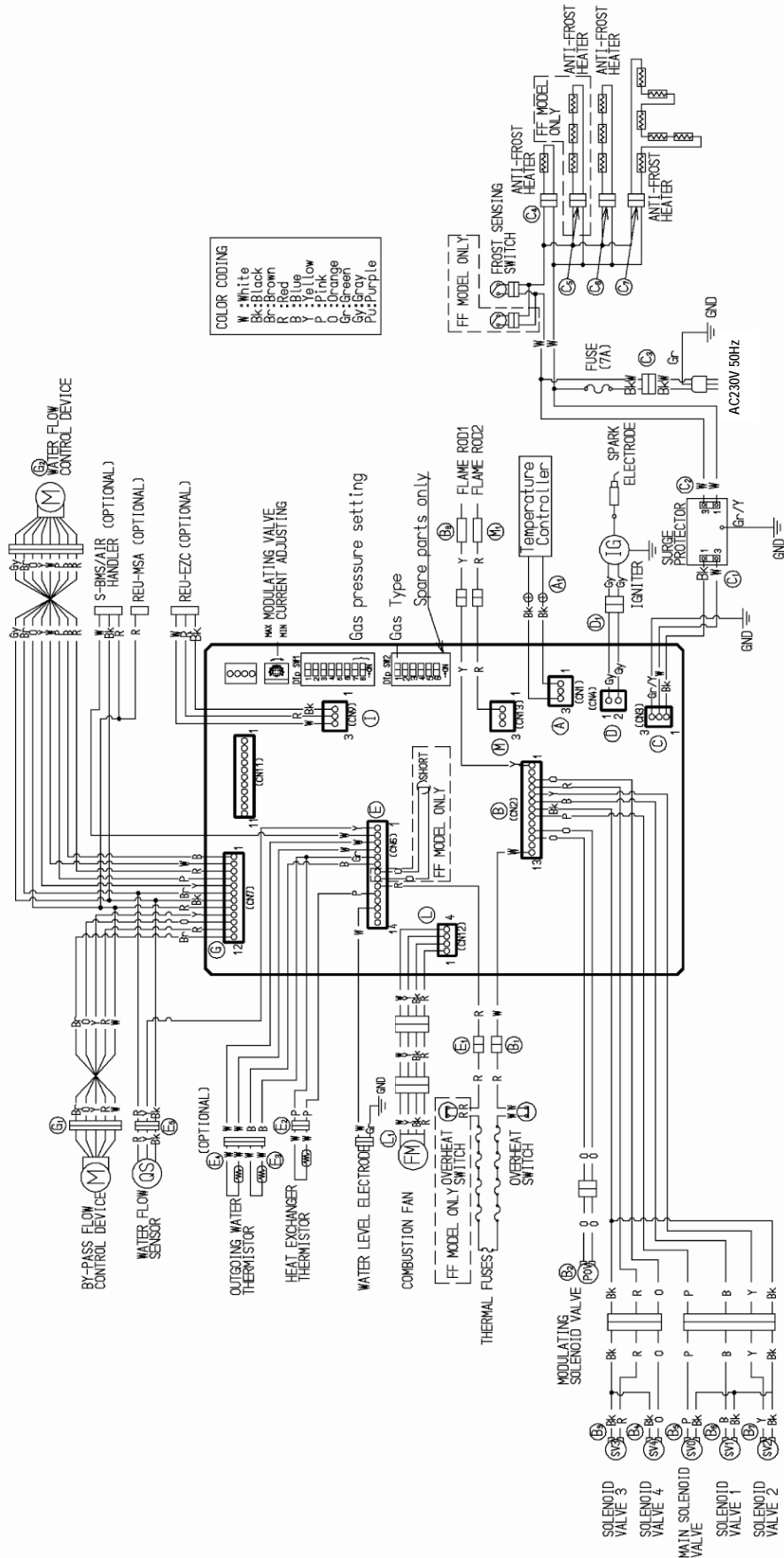



# DIAGNOSTIC POINTS

## Infinity K32

COMPONENT	MEASUREMENT POINT		RANGE OF VALUE	REMARKS
	CN	WIRE COLOUR		
REMOTE CONTROLLER	A1	Bk-Bk	DC11-13V	
THERMAL FUSE	B1/E1	W-R	129°C BELOW 1Ω	
MODULATION VALVE	B2	O-O	DC2-15V / 67-82Ω	
MAIN SOLENOID VALVE	B3	P-Bk	DC11-13V / 37-43Ω	
SOLENOID VALVE 1	B4	B-Bk	DC11-13V / 37-43Ω	
SOLENOID VALVE 2	B5	Y-Bk	DC11-13V / 37-43Ω	
SOLENOID VALVE 3	B6	R-Bk	DC11-13V / 37-43Ω	
SOLENOID VALVE 4	B7	O-Bk	DC11-13V / 37-43Ω	
FLAME ROD 1	B8	Y-FR	OVER 1μA (DURING OPERATION)	
FLAME ROD 2	M1	R-FR	OVER 1μA (DURING OPERATION)	
SURGE PROTECTOR	C1	W-Bk	AC207-264V	
SURGE PROTECTOR	C2	W-Bk	AC207-264V	
MAIN POWER CODE	C3	W-Bk	AC207-264V	
ANTI-FROST HEATER	C4	Y-Y	7254-6346Ω	
ANTI-FROST HEATER	C5	Y-Y	1025-1179Ω	FF MODEL ONLY
ANTI-FROST HEATER	C6	Y-Y	1396-1543Ω	
ANTI-FROST HEATER	C7	Y-Y	385-443Ω	
IGNITOR	D1	Gy-Gy	AC207-264V (DURING IGNITION)	
HEAT EXCHANGER TH	E2	W-W	15°C:11.4-14.0kΩ 30°C:16.4-7.8kΩ	
OUTGOING WATER TH1	E3	W-W	45°C:3.6-4.5kΩ 60°C:2.2-2.7kΩ	
OUTGOING WATER TH2	E4	B-B	100°C:0.6-0.8kΩ	
WATER FLOW SENSOR	E5	R-Bk	DC11-13V	ON: 2.4L/MIN(33Hz) OVER 1980 PULSE/MIN OFF: 1.7L/MIN(23Hz) OVER 1380 PULSE/MIN
BY-PASS FLOW CONTROL DEVICE	G1	Br-W O-W Y-W R-W	DC12V (DC2-6V DURING OPERATION) 15-35Ω	
WATER FLOW CONTROL DEVICE	G2	R-O P-O B-O W-O R-P B-W	DC11-13V (DC5-7V DURING OPERATION) 30-50Ω	
COMBUSTION FAN	L1	Y-Gy Br-Gy R-Bk Y-Bk W-Bk	BELOW DC1V (LIMITER ON) DC4-6V (LIMITER OFF) BELOW DC1V (LIMITER ON) DC4-6V (LIMITER OFF) DC15-46V DC11-13V	FULL OPEN POSITION FULL OPEN POSITION FULL CLOSE POSITION
OVERHEAT SWITCH	Br/E1	W-R	DC5-10V (PULSE 20-400Hz) 97°C (+/-4°C)	

## Infinity K26

COMPONENT	MEASUREMENT POINT		RANGE OF VALUE	REMARKS
	CN	WIRE COLOUR		
REMOTE CONTROLLER	A1	Bk-Bk	DC10-13V	
THERMAL FUSE	B1/E1	W-R	129°C - BELOW 1Ω	
MODULATION VALVE	B2	O-O	DC2-15V / 67-82Ω	
MAIN SOLENOID VALVE	B6	P-Bk	DC11-13V / 37-43Ω	
SOLENOID VALVE 1	B6	B-Bk	DC11-13V / 37-43Ω	
SOLENOID VALVE 2	B7	Y-Bk	DC11-13V / 37-43Ω	
SOLENOID VALVE 3	B3	R-Bk	DC11-13V / 37-43Ω	
SOLENOID VALVE 4	B4	O-Bk	DC11-13V / 37-43Ω	
FLAME ROD 1	B8	Y-FR	OVER 1μA (DURING OPERATION)	
FLAME ROD 2	M1	R-FR	OVER 1μA (DURING OPERATION)	
SURGE PROTECTOR	C1	W-Bk	AC207-264V	
SURGE PROTECTOR	C2	W-Bk	AC207-264V	
OVERHEAT SWITCH	Br/E1	W-W	97°C (+/-4°C)	
IGNITOR	D1	Gy-Gy	AC207-264V (DURING IGNITION)	
HEAT EXCHANGER TH	E2	W-W	15°C:11.4-14.0kΩ 30°C:16.4-7.8kΩ	
OUTGOING WATER TH1	E4	W-W	45°C:3.6-4.5kΩ 60°C:2.2-2.7kΩ	
OUTGOING WATER TH2	E3	B-B	100°C:0.6-0.8kΩ	
WATER FLOW SENSOR	E5	R-Bk	DC11-13V	ON:2.4L/MIN(33Hz) OVER 1980 PULSE/MIN OFF:1.7L/MIN(23Hz) OVER 1380 PULSE/MIN
BY-PASS FLOW CONTROL DEVICE	G1	Br-W O-W Y-W R-W	DC12V (DC2-6V DURING OPERATION) 15-35Ω	
WATER FLOW CONTROL DEVICE	G2	R-O P-O B-O W-O R-P B-W	DC11-13V (DC5-7V DURING OPERATION) 30-50Ω	
COMBUSTION FAN	L1	Y-Gy Br-Gy R-Bk Y-Bk W-Bk	BELOW DV1V (LIMITER ON) DC4-6V (LIMITER OFF) BELOW DV1V (LIMITER ON) DC4-6V (LIMITER OFF) DC6-45V DC11-13V	FULL OPEN POSITION FULL OPEN POSITION
MAIN POWER CODE	C3	W-Bk	DC5-10V (PULSE 20-400Hz) AC207-264V	

# WATER FLOW CHARACTERISTICS

## Infinity K32

WATER PRESSURE / VOLUME

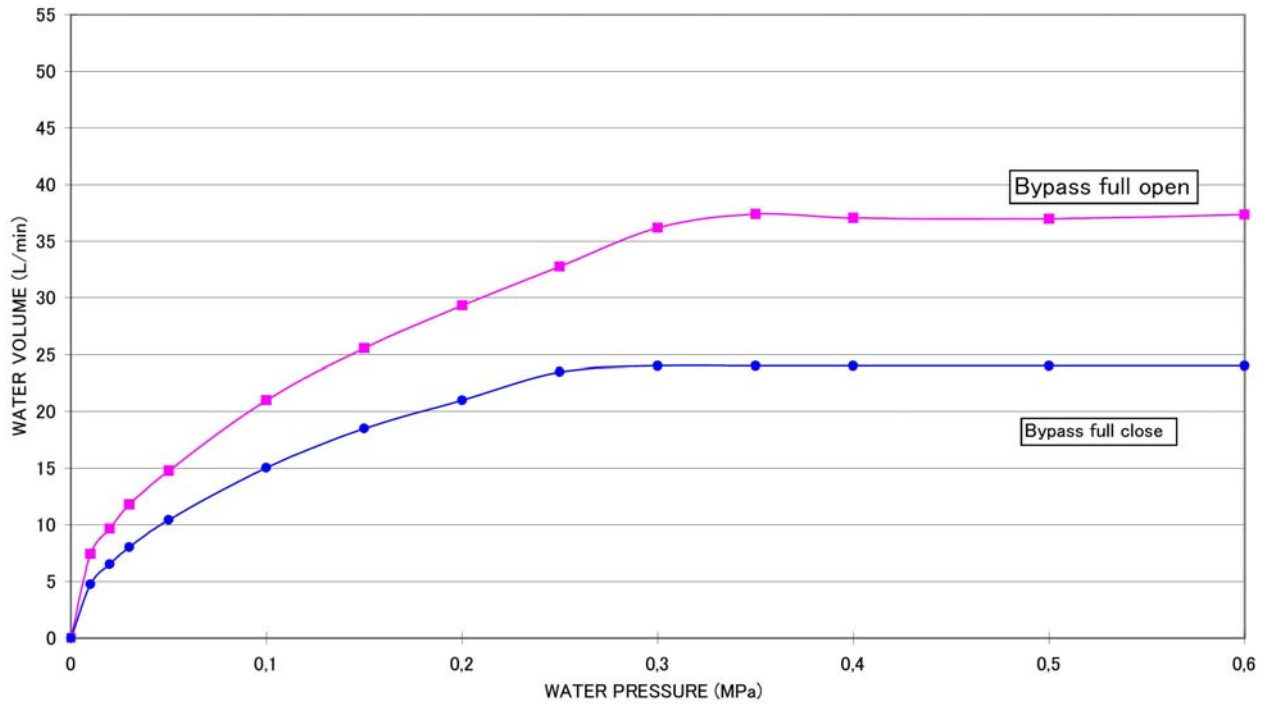

## Infinity K26

WATER PRESSURE / VOLUME

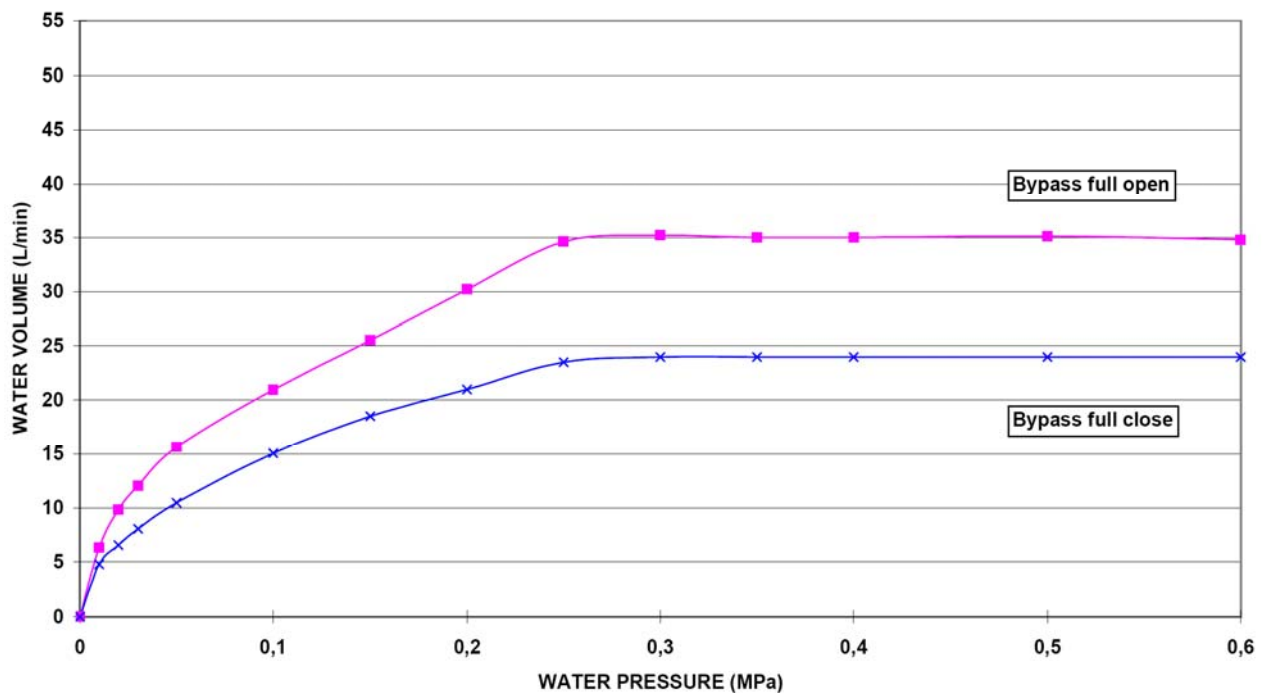

# LETTER OF COMPLIANCE

## Conformity Declaration

We, Rinnai Corporation, Nagoya herewith confirm that the following models:

REU-KM3237WD-E  
REU-KM3237FFUD-E  
REU-KM3237FFUDHD-E  
REU-KM3237WDHD-E

REU-KM2635WD-E  
REU-KM2635FFUD-E  
REU-KM2635FFUDHD-E  
REU-KM2635WDHD-E

comply with the directives mentioned below:

2009/142/EC Gas Directive  
73/23/EEG Low Voltage Directive  
89/336/EEG EMC Directive

The following harmonized standard has been used:

*Gas-fired instantaneous water heaters for the production of domestic hot water, fitted with atmospheric burners (EN26)*

Nagoya, 15th. February Rinnai Corporation



Shinji Tanaka,  
General Manager

# CE CERTIFICATE



Technigas

Module B

## EC TYPE EXAMINATION CERTIFICATE

Annex II Paragraph I directive 90/396/EEC

Certificate number : E1188/5560 Rev.1

Date of issue : 01/09/2009

ID number : 0461BU0950

Revised : 02/02/2010

Fabricant : RINNAI Corporation

Manufacture : Fukuzumi-Cho 2-26

Fabrikant : Nakagawa, Nagoya

Marque commerc. : RINNAI

Trade mark

Handelsmerk

Type : REU-KM3237FFUD-E / REU-KM3237FFUDHD-E

Model : REU-KM2635FFUD-E / REU-KM2635FFUDHD-E

Type

Genre d'appareil : Condensing Water Heater

Kind of product

Soort toestel

Type d'appareil : C13/ C33

Appliance type

Type toestel

Countries of destination, appliance categories :

AL-AT-BE-BG-CH-CY-CZ-DE-DK-EE-ES-FI-FR-GB-GR-HU-HR  
IE-IS-IT-LT-LU-LV-MK-MT-NL-NO-PL-PT-RO-SE-SI-SK-TR

I2H // I2L // I2E // I2E(S) // I2Esi // I2HM // I3B/P // I3P

G20-20 mbar // G25-25 mbar // G20/G25-20/25 mbar // G30-28/30 mbar //  
G30-30 mbar // G30-37 mbar // G31-30 mbar // G31-37 mbar // G31-50 mbar  
G230-20mbar

Normative references: EN 26

This document cancels and replaces the previous one of : 01/09/2009

DIRECTOR  
K DE WIT



TGP-08-14  
2002-04-12

TECHNIGAS - Rodestraat, 125 - B-1630 Linkebeek  
Phone +32 2 383 02 00 - Fax +32 2 380 87 04  
e-mail : [technigas@technigas.be](mailto:technigas@technigas.be) - website : [www.technigas.be](http://www.technigas.be)

# CE CERTIFICATE



**Technigas**

Module B

## EC TYPE EXAMINATION CERTIFICATE

Annex II Paragraph I directive 90/396/EEC

Certificate number : E1189/5560 Rev.1

Date of issue : 01/09/2009

ID number : 0461BU0950

Revised : 02/02/2010

Fabricant : RINNAI Corporation

Manufacture : Fukuzumi-Cho 2-26

Fabrikant : Nakagawa, Nagoya

Marque commerc. : RINNAI

Trade mark

Handelsmerk

Type : REU-KM3237WD-E / REU-KM3237WDHD-E

Model : REU-KM2635WD-E / REU-KM2635WDHD-E

Type

Genre d'appareil : Condensing Water Heater

Kind of product

Soort toestel

Type d'appareil : A3 – Only outdoor installation

Appliance type

Type toestel

Countries of destination, appliance categories :

AL-AT-BE-BG-CH-CY-CZ-DE-DK-EE-ES-FI-FR-GB-GR-HU-HR  
IE-IS-IT-LT-LU-LV-MK-MT-NL-NO-PL-PT-RO-SE-SI-SK-TR

I2H // I2L // I2E // I2E(S) // I2Esi // I2HM // I3B/P // I3P

G20-20 mbar // G25-25 mbar // G20/G25-20/25 mbar // G30-28/30 mbar  
G30-30 mbar // G30-37 mbar // G31-30 mbar // G31-37 mbar // G31-50 mbar  
G230-20mbar

Normative references: EN 26

This document cancels and replaces the previous one of : 01/09/2009

DIRECTOR  
K DE WIT



TGP-08-14  
2002-04-12

TECHNIGAS - Rodestraat, 125 - B-1630 Linkebeek  
Phone +32 2 383 02 00 - Fax +32 2 380 87 04  
e-mail : [technigas@technigas.be](mailto:technigas@technigas.be) - website : [www.technigas.be](http://www.technigas.be)

# COMMISSIONING CHECK LIST

## Attention Installer - have you checked!

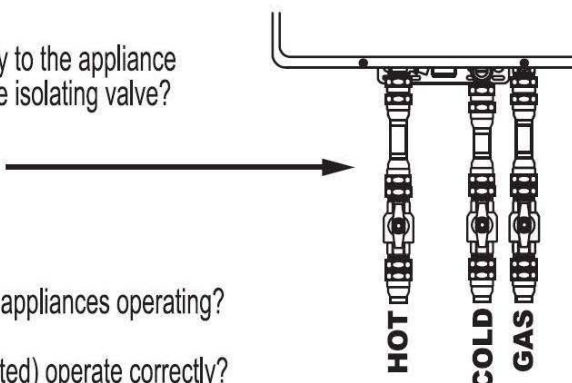
- Gas supply pipe is purged of foreign matter before connection.
- For Hot and Cold cross connections i.e. Capped breaches / Shower Mixers, taps closed and reversed 'Flick Mixer' connections?
- That isolating valves are not connected directly to the appliance and there is a means of disconnection after the isolating valve?
- That plumbing connections are correct? 
- Have you turned on the power?
- Is appliance inlet gas pressure correct with all appliances operating?
- Do the Kitchen and Bathroom Controllers (if fitted) operate correctly?
- Tempering Valve (if fitted)
- Have you checked water temperature at all outlets?
- Have you cleaned cold water inlet filter?
- Have you shown the customer how to operate the Temperature Controllers? (If fitted)
- Have you explained to the Customer the Benefits of Controllers (if not fitted) and that they can be added later?
- Have you explained to the customer the minimum flow rate required to operate the unit?
- Have you checked the flue clearances and installation?
- Have you connected a condensate drain pipe in accordance with the installation Instructions.

### **For Internal (FFU) models only**

- Have you used only Rinnai FF flueing components?
- If flue length exceeds 7m, dip-switch 1 of SW1 is to be switched to the 'OFF' position as shown.
- If flue length exceeds 2m, connect a condensate drain pipe in accordance with the FF flueing instructions.

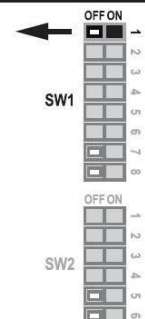

### **PLEASE NOTE:**

*That warranty may be voided and a service charge may be incurred as a result of Rinnai staff attending to a problem related to installation.*

# MAINTENANCE

## Maintenance

Maintenance of Infinity is very limited.

For more detailed instructions on maintenance contact Rinnai or your supplier.

Below is reported the flushing procedure of the heat exchanger.

### Flushing the heat exchanger:

An "LC" or "00" error code indicates the unit is beginning to lime up and must be flushed. Failure to flush the appliance will cause damage to the heat exchanger. Damage caused by lime build-up is not covered by the unit's warranty. After flushing, reset the LC fault code by turning off the power to the unit and turning the power back on.

1. Disconnect electrical power to the water heater.
2. Close the shutoff valves on both the hot water and cold water lines (V3 and V4).
3. Connect pump outlet hose (H1) to the cold water line at service valve V2.
4. Connect drain hose (H3) to service valve V1.
5. Pour approximately 4 gallons of virgin, food grade, white vinegar or citric acid into pail.
6. Place the drain hose (H3) and the hose (H2) to the pump inlet into the cleaning solution.
7. Open both service valves (V1 and V2) on the hot water and cold water lines.
8. Operate the pump and allow the cleaning solution to circulate through the water heater for at least 45 minutes.
9. Turn off the pump.
10. Rinse the cleaning solution from the water heater as follows:
  - a. Remove the free end of the drain hose (H3) from the pail.
  - b. Close service valve, (V2), and open shutoff valve, (V4). Do not open shutoff valve, (V3).
  - c. Allow water to flow through the water heater for 5 minutes.
  - d. Close service valve, (V1), and open shutoff valve, (V3).
11. Disconnect all hoses.
12. With (V4) closed, remove the in-line filter at the cold water inlet and clean out any residue. Place filter back into unit and open (V4).
13. Restore electrical power to the water heater.

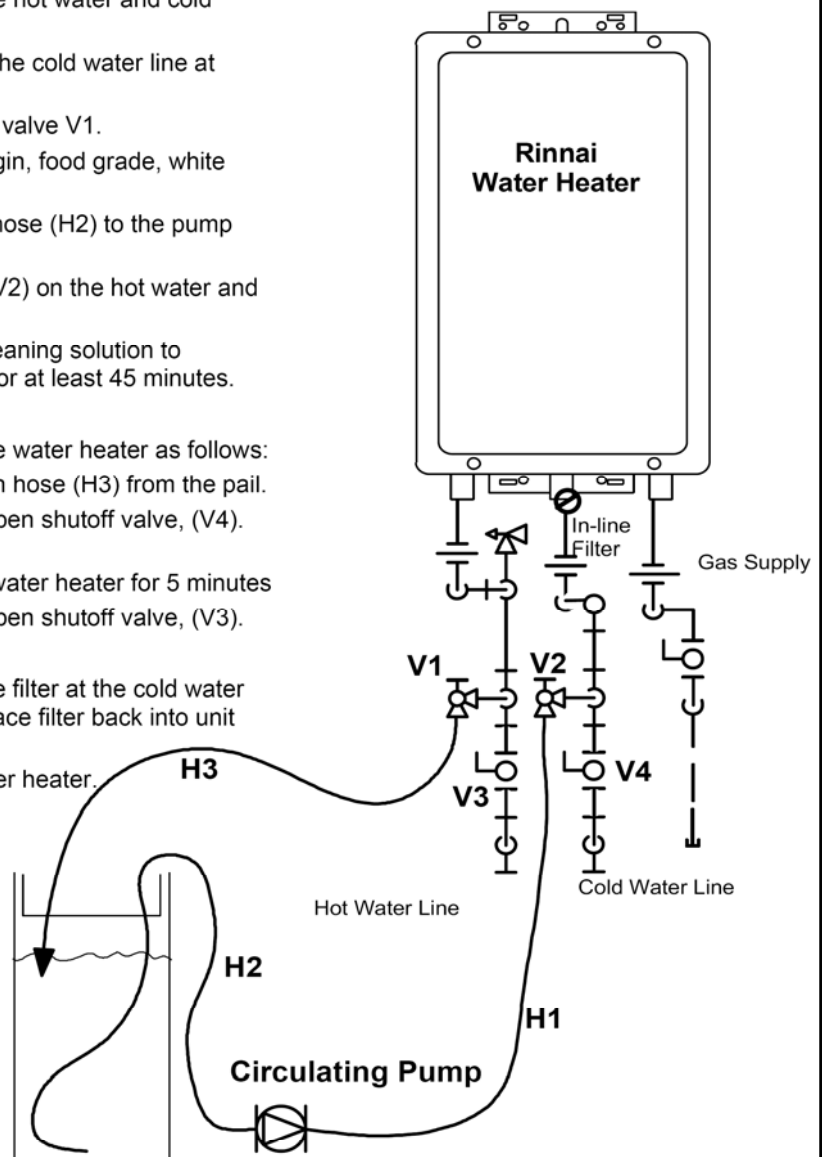

### KEY

	3/4" Ball Valve		Pressure Regulator
	3/4" Union		Circulating Pump
	Check Valve		Boiler Drain Valve
	Pressure Relief Valve		Solenoid Valve



# UK WARRANTY

As the purchaser of this high quality Rinnai Water Heater you are provided with the following conditional warranty.

	Heat Exchanger		All Other Parts	
	Parts	Labour	Parts	Labour
<b>Standard Use</b>	3 Years	1 Year	3 Years	1 Year
Infinity K32e / K32i Infinity K26e / K26i				
<b>Commercial Use</b>	5 Years	1 Year	5 Years	1 Year
Infinity HDC 1500e / HDC1500i Infinity HDC 1200e / HDC1200i				

### Definition of Standard Use.

The warranty period allocated under Standard Use is based on Domestic and Light Commercial hot water usage. Rinnai Standard Use warranty periods apply only where Rinnai water heaters are installed in domestic and light commercial situations at operating temperatures below 65°C and do not include installations incorporating storage cylinders or building flow and return systems.

The warranty shall apply to any Rinnai water heater from the Infinity or HDC range used in this way.

### Definition of Commercial Use.

The warranty period allocated under Commercial Use are for Rinnai HDC water heaters installed at premises such as commercial and industrial buildings, cafes, caravan parks, and sporting complexes. Commercial Use warranty applies to:

- Water heaters supplying a central shower block.
- Water heaters supplying kitchens used for the bulk preparation of food.
- Water heaters set to 65°C or higher.
- Water heaters used in commercial or industrial processes.
- Any application that uses Rinnai water heaters in conjunction with storage tanks.
- Any application that uses Rinnai water heaters in conjunction with a flow / return system.
- Water heaters installed as components of centralised bulk hot water systems.

Situations defined as Commercial Use MUST have the Rinnai HDC range of water heaters to be eligible for the Commercial Use warranty. Rinnai Infinity units used in Commercial Situations are only subject to a 1 year warranty across the board.

No Rinnai warranty will cover damage/ faults arising from moving or storing the unit; improper installation or gas supply; water contaminants beyond defined limits; environmental factors; plumbing fittings, or other outside influences of which Rinnai is not responsible. Service calls for these issues will be chargeable. The unit must be serviced annually to validate the warranty.

The warranty period begins on customer's date of purchase.

Description	pH	Total Dissolved Solids (TDS)	Total Hardness	Chlorides	Magnesium	Calcium	Sodium	Iron
Maximum Recommended Levels	6.5 - 9.0	600 mg/litre	150 mg/litre	300 mg/litre	10 mg/litre	20 mg/litre	150 mg/litre	1 mg/litre



# UK WARRANTY

## **WHAT IS COVERED?**

This Warranty covers any defects in materials or workmanship when the product is installed and operated according to Rinnai installation instructions, subject to the terms within this limited warranty document. This Warranty applies only to products that are installed by a registered gas engineer. Improper installation may void this Warranty. This Warranty extends to the original purchaser and subsequent owners, but only while the product remains at the site of the original installation. This Warranty only extends through the first installation of the product and terminates if the product is moved or reinstalled at a new location.

## **WHAT WILL RINNAI DO?**

Rinnai will repair or replace the product or any part or component that is defective in materials or workmanship, except as set forth below: All repairs must be performed using genuine Rinnai parts. All repairs or replacements must be performed by a registered gas engineer. Replacement of the product or replacement of the heat exchanger may only be authorised by Rinnai. Rinnai does not authorise any person or company to assume for it any obligation or liability in connection with the replacement of a product or heat exchanger. If Rinnai determines that repair of a product is not possible, Rinnai will replace the product with a comparable product, at Rinnai's discretion. If a component or product returned to Rinnai is found to be free of defects in material or workmanship, or damaged by improper installation the warranty claim may be denied.

## **HOW DO I GET SERVICE?**

Contact your supplier or Rinnai UK.

Proof of date of purchase is required to obtain warranty service. You can show proof of purchase with a dated invoice or by completing and returning the enclosed Warranty registration card.

Receipt of warranty registration by Rinnai will constitute proof-of-purchase for this product. However, Warranty registration is not necessary in order to validate this Warranty.

## **WHAT IS NOT COVERED?**

This Warranty does not cover any failures or operating difficulties due to accident, abuse, misuse, alteration, misapplication, acts of God, improper installation, improper maintenance or service, inadequate water quality, scale buildup, freeze damage or for any other causes other than defects in materials or workmanship. This warranty does not apply to any product whose serial number or manufacture date has been defaced.

This Warranty does not cover any product when used as a pool or spa heater.

Rinnai is not liable for any special, incidental, indirect or consequential damages that may arise, including damage to person or property, loss of use, failure to install drain pan under unit, or inconvenience.

This warranty does not effect your statutory rights as defined in the UK.

# SPECIFICATION

**Model.....Infinity K32e / HDC1500e and K32i / HDC1500i**

**Installation..... Internal or external depending on model**

**Fuel.....NG or LPG \***

**Control.....Modulating**

**Exhaust type.....Forced Draught Flue**

**Ignition.....Electronic**

**Burner.....Stainless steel**

**Weight.....31 kg**

**Water flow rate .....1.5\*\* to 37 L/min**

**Minimum operating water pressure.....1.0 Bar**

### Connections

**Gas.....3/4BSP**

**Water Inlet.....3/4BSP**

**Water outlet.....3/4BSP**

**Condensate outlet.....1/2BSP**

**Electrical Supply.....230V AC 50Hz 1ph**

\* Separate models available for Natural gas or LPG fuel.

\*\* Minimum flow rate based on temperature set point and inlet conditions.

Rinnai are continually updating and improving products and reserve the right to alter model specifications without prior notice.

**Model.....Infinity K26e / HDC1200e and K26i / HDC1200i**

**Installation..... Internal or external depending on model**

**Fuel.....NG or LPG \***

**Control.....Modulating**

**Exhaust type.....Forced Draught Flue**

**Ignition.....Electronic**

**Burner.....Stainless steel**

**Weight.....29 kg**

**Water flow rate .....1.5\*\* to 35 L/min**

**Minimum operating water pressure.....1.0 Bar**

### Connections

**Gas.....3/4BSP**

**Water Inlet.....3/4BSP**

**Water outlet.....3/4BSP**

**Condensate outlet.....1/2BSP**

**Electrical Supply.....230V AC 50Hz 1ph**

\* Separate models available for Natural gas or LPG fuel.

\*\* Minimum flow rate based on temperature set point and inlet conditions.

Rinnai are continually updating and improving products and reserve the right to alter model specifications without prior notice.

## CONTACT

### **Rinnai** UK LTD.

9 Christleton Court

Manor Park

Runcorn

Cheshire

WA7 1ST

Tel. 01928 531870

Fax. 01928 531880

E-mail. [info@rinnaiuk.com](mailto:info@rinnaiuk.com)

Web. [www.rinnaiuk.com](http://www.rinnaiuk.com)

## HEATER DETAILS

Model Number \_\_\_\_\_

Serial Number \_\_\_\_\_

Date of Purchase \_\_\_\_\_

